

## INFRARED TOMOGRAPHY SENSOR CONFIGURATION USING 4 PARALLEL BEAM PROJECTIONS

YUSRI MD. YUNOS<sup>1\*</sup>, MUHAMMAD SAIFUL BADRI MANSOR<sup>2</sup>, NOR  
MUZAKKIR NOR AYOB<sup>3</sup>, PANG JON FEA<sup>4</sup>, RUZAIRI ABDUL RAHIM<sup>5</sup> &  
CHAN KOK SAN<sup>6</sup>

**Abstract** This paper represents the configuration of optical tomography sensor by using infrared emitter and phototransistor. The projection geometry of the sensor is based on the combination of two orthogonal and two rectilinear projections arrays. A fixture is designed for holding all emitter-receiver pairs in parallel. Selection of phototransistor is explained so that the tomography sensor developed is free of noise cause by surrounding environment. This paper describes all points to be considered when design an optical tomography sensor.

*Keywords:* Infrared; optical tomography

**Abstrak.** Penyelidikan ini menunjukkan konfigurasi sensor tomografi optik dengan penggunaan pemancar inframerah dan foto transistor. Geometri unjuran sensor adalah berdasarkan kombinasi dua unjuran oktagon dan dua unjuran garis lurus tatasusunan. Sebuah perlengkapan direka untuk memegang keseluruhan pasangan pemancar-penerima secara selari. Pemilihan foto transistor juga dijelaskan supaya pembangunan sensor tomografi adalah bebas dari bacaan yang tidak diinginkan daripada persekitaran sekeliling. Penulisan ini juga menerangkan perkara-perkara yang perlu dipertimbangkan untuk pembangunan sensor tomografi optikal.

*Kata kunci:* Inframerah; tomografi optikal

### 1.0 INTRODUCTION

Process tomography involves the acquisition of measurement signals from sensors located at the periphery of an object (Williams and Beck, 1995). The parameter

---

<sup>1,4,5,6</sup> Process Tomography Research Group (PROTOM), Control and Instrumentation Engineering Department, Faculty of Electrical Engineering, Universiti Teknologi Malaysia, 81310 UTM Johor Bahru, Johor Darul Ta'azim

<sup>2,3</sup> Biomedical Electronic Engineering, School of Mechatronic Engineering, University Malaysia Perlis, 02600 Jejawi, Arau, Perlis, Malaysia

\* Corresponding author; [yusri@fke.utm.my](mailto:yusri@fke.utm.my)

or characteristic to be imaged is determined by the type of sensor chosen, such as gamma-rays and X-rays are sensitive to density, while capacitance sensors are sensitive to the dielectric constant of the object. To construct cross-sectional the sensor signals are amplified, filtered, digitized and finally be processed in a computer using certain image reconstruction algorithm. Normally, most of the flow information is based on the cross-sectional image. For example, the cross-sectional image itself already provides flow material's concentration. On the other hand, hundreds set of upstream and downstream images can provide flow velocity when correlation function is applied in this case. As a result, process tomography will provide an increase in the quantity and quality of information when compared to many earlier measurement techniques (Ruzairi, 1996).

## **2.0 OVERVIEW OF OPTICAL TOMOGRAPHY SENSOR**

Optical tomography involves the use of non-invasive optical sensors to obtain vital information in order to produce images of the dynamic internal characteristics of process system (Sallehuddin *et al.*, 2000). It has the advantages of being conceptually straightforward and relatively inexpensive. The optical tomography system uses a number of light emitter-receiver pairs and a wide variety of light sources such as visible light, infrared or laser light.

A general optical tomography system requires a sensor fixture, a number of optical sensor arrays, signal measurement circuitry, data acquisition system and a computer as data processing unit and display unit. Its working principle involves projecting a beam of light through a medium from one boundary point and detecting the level of light received at another boundary point (Ruzairi, 1996). For the type of projection used in the system, it can be parallel beam (orthogonal) projection, rectilinear projection, fan beam projection or mix projection among them.

Optical tomography has the application of pneumatic conveying in the industry of food processing, plastic product manufacturing and solids waste treatment. The specific measurements of it are flow concentration, flow velocity and mass flow rate determination. Besides, optical tomography sensor also can measure gas bubbles and particles in conveying fluid.

### 3.0 SYSTEM DESIGN

In optical tomography system, the two types of sensor arrangement techniques that have been investigated and applied to measure gas/solid flows are parallel beam projection and fan beam projection. For parallel beam projection, the number of emitter and receiver are the same. Each pair of transmitter-receiver is arranged in a straight line and the received signal only corresponds to its emitter source. While for fan beam projection, the number of emitters and receivers can be unequal. A multiplexing source is used and all the receivers produce the signals corresponding to each multiplexed source. The fan beam projection technique provides a higher resolution system compared to the same number of sensors used in parallel projection due to high obtaining information (Chan, 2002). However, it has the weakness like hard to model the sensitivity map of each sensor projection in forward problem and a longer time to reconstruct the cross-sectional image compared to parallel beam projection technique.

A typical optical tomography system consists of a sensor, an electronic circuit, a data acquisition system, and a host computer as data processing and display unit. For the developed system, the block diagram of Figure 1 is applied. A transmitter circuit will switch on the emitters' light and project them to receivers. The signal conditioning circuit now converts the signals received into voltage readings and then amplifies them to a sufficient level. Finally, the output signals pass through sample and hold circuit to the analogue switching circuit and the data acquisition system based on the control signals from digital signal controller. Next, data acquisition system will digitise the signals and flow them into computer for further processing.

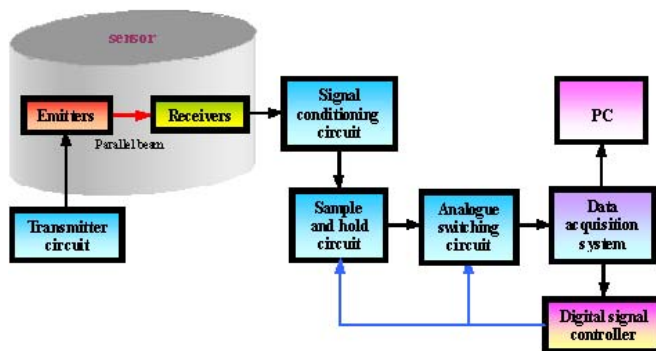
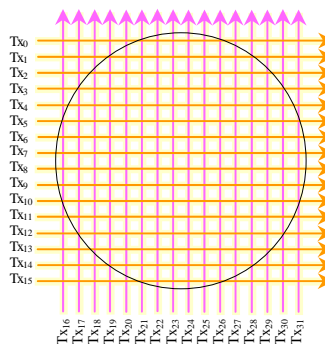

Figure 1 Block diagram of developed system

## 4.0 PROJECTION GEOMETRY

The parallel beam projection can be obtained through the arrangement of several transmitter sensors in a straight line and the view angle of each sensor is considered small enough. This type of projection results in patterns of two orthogonal projections, two rectilinear projections, combination of one orthogonal with two rectilinear projections and combination of two orthogonal with two rectilinear projections (Sallehuddin, 2000). The developed system adopts the last projection pattern because it can provide sufficient information to prevent as much as possible ambiguous effect from arising during cross-sectional image detection compared to the previous three projections.

The selected two orthogonal and two rectilinear projections are shown in Figure 2.1 and Figure 2.2. In the two orthogonal projections, there are two arrays of projections. One is parallel to the horizontal axis while the other one is parallel to the vertical axis. In this system, one array of projections uses 16 pairs of transmitter-receiver and this result in true image resolution of 16x16 pixels. For the two rectilinear projections, both arrays of projections are inclined plus and minus  $45^\circ$  to the horizontal axis respectively. The number of transmitter-receiver pairs used in one array is 23 because each emitter projection in this layer must cross over the centre point of the corresponding pixel and also the area within the pipeline (refer Figure 2.3). The hardware resolution in this project doubles the resolution obtained from the previous research conducted by (Sallehuddin , 2000) that used 8x8 pairs of transmitter-receiver in the layer of two orthogonal projections and 11x11 pairs of transmitter-receiver in the layer of two rectilinear projections.



**Figure 2.1** Two orthogonal projections

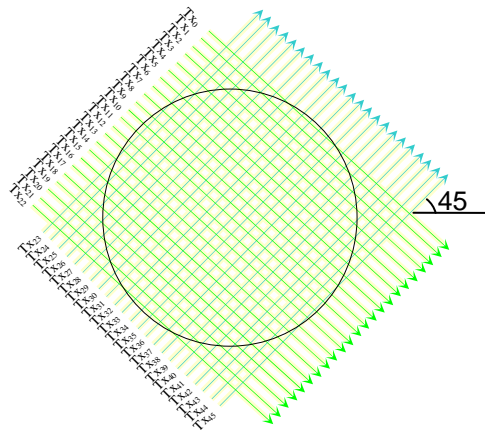

**Figure 2.2** Two rectilinear projections

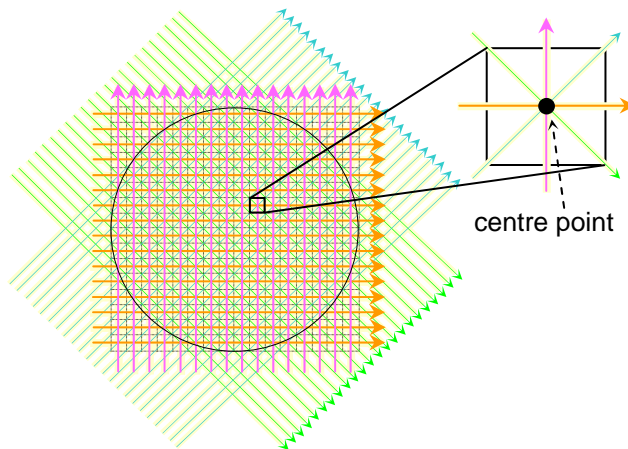

**Figure 2.3** Combination of two orthogonal and two rectilinear projections

## 5.0 SELECTION OF EMITTER AND RECEIVER

The previous research by (Chan, 2002) successfully applied the LED as the emitter in optical tomography system. However, the light of LED is visible light with the wavelength in between 380-700 nm and therefore results in the tomography sensor designed is easily getting noise from the surrounding environment light source. It must be noted that most of the light sources such as

incandescent lamp and fluorescent light (peak of radiant power at 550 nm) are widely used in the indoor factory. Unless there are solutions to prevent the surrounding light from projecting into tomography sensor, it is not suitable to be used in most of the indoor factories.

By referring to Figure 3, the wavelength of infrared is in between 700 – 1000nm. It is far away from the wavelength of fluorescent light and this is the reason that infrared emitter is used in this project. The infrared emitter model, TSUS4300 from TEMIC Semiconductor is chosen because of some main reasons, such as its physical size with 3 mm in diameter, wavelength in the range of 900 to 1000 nm, peak of wavelength at 950 nm, small angle of half intensity which is 16 degree and can be easily acquired from the local market.

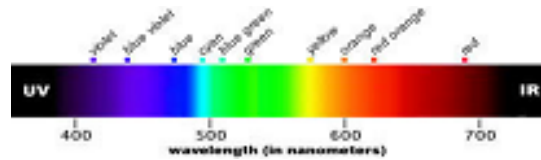

**Figure 3** Wavelength of light

Regarding to the photo-detector selection, the photodiode and phototransistor were being considered because their physical sizes are small, wavelength covering infrared light and also inexpensive. However, the final selection is the phototransistor based on two factors. First, the phototransistor model, TEFT4300 is specifically manufactured for the IR emitter TSUS4300. Second, based on the graph of spectral sensitivity versus wavelength in the corresponding datasheet, the starting wavelength of phototransistor TEFT4300 is about 875 nm, which is quite a distance away from the visible light's boundary, 700 nm. But, most of the photodiodes have the starting value from the visible light's wavelength. Besides, its physical size with 3 mm in diameter, peak of wavelength at 925 nm and angle of half sensitivity is 30 degree.

## 6.0 OPTICAL SENSOR FIXTURE DESIGN

The fixture is designed for holding all emitters and receivers so that 4 parallel projections beams' arrays can be created easily. For one optical sensor, the two orthogonal projections and two rectilinear projections are in the same layer.

Practically, if all projections in one layer were to be made, three main problems will occur. First, Light from emitter must travel a longer distance to arrive receiver since the inner diameter of pipe used in system is already 85 mm. It means that the emitter itself must have a higher intensity capability. Unfortunately, for the emitter that has higher intensity, the physical size will be greater than 3 mm in diameter and also the cost highly. Second, the developed fixture will look bulky. Third, since the radiant intensity of emitter is proportional to the forward current used, thus the power used for the whole system will increase. As a result, the fixture was constructed using two layers as shown in Figure 4. The upper layer is for two rectilinear projections and it contains 92 holes in total, 23 holes per side. The lower layer is for two orthogonal projections and it contains 64 holes in total, 16 holes per side. The distance between these two layers is 7 mm to prevent cracking in between both layers.

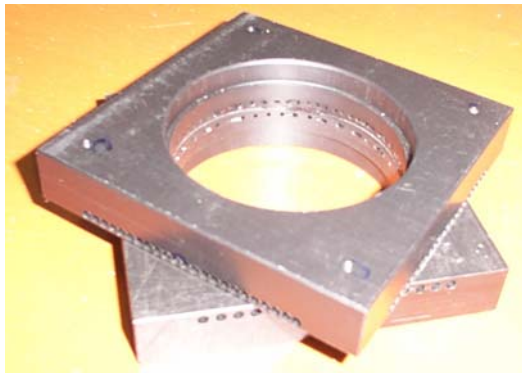

**Figure 4** Fixture for holding emitters and receivers

The beam of light must diverge as little as possible to avoid overlapping of the received signals and looseness of the beam intensity (Ruzairi, 1996). Three methods are used to collimate the light source. First, uses infrared emitter and phototransistor that have small view angle. Second, places an optical stopper in front of the infrared emitter. In this system, ferrule is used as the stopper. This method is rather effective to limit the divergent angle (Chan, 2001). The stopper is 1 mm in diameter and it successfully limits the light from the 3 mm infrared emitter as shown in Figure 5. Third, arrange all emitters and receivers in an alternate arrangement as shown in Figure 5. This arrangement helps to cut down

the light divergent effect towards other sensors especially the receiver residing next to the designated receiver (Chan, 2001).

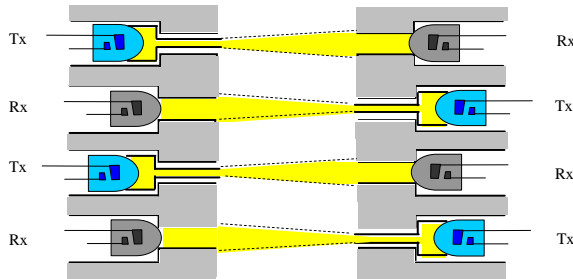

**Figure 5** Optical stopper and alternate arrangement of sensors

## 7.0 INFRARED PROJECTION CIRCUIT

In developed system, a simple circuit is used and it connects the infrared emitter to a 100 ohm resistor with 5 volt supply. The circuit provides 50 mA to the emitter and it is good enough for the radiant intensity to project over 100 mm in distance.

## 8.0 SIGNAL CONDITIONING CIRCUIT

The TEFT4300 phototransistor is a type of NPN transistor but no base connection available because the absorbed light plays the role of base current. The current created by the absorbed light is amplified by the bipolar action of the transistor, leading to a relatively large current flowing from collector to emitter. The phototransistor has higher sensitivity than the photodiode, so it produces more current for a given amount of incident light. Figure 6 shows the signal conditioning circuit that is specifically designed for this system. There are some factors that have to be considered when designing this circuit, such as the physical sizes of components, output voltage relative to light absorbed and components' cost. This circuit uses transistor instead of operational amplifier (op-amp) for signal amplification since the physical size of transistor is smaller and consists of 3 pins only. An important feature of the circuit is when no light is absorbed (object



blocks the light), the output voltage produced is 5 volt; when light is absorbed (light not blocked), the output voltage produced is 0 volt. This feature can save the computation time in further processing of cross-correlation function in velocity measurement.

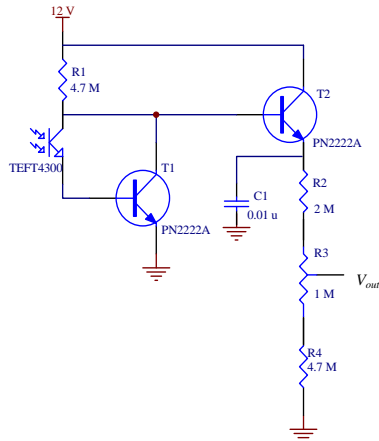

**Figure 6** The signal conditioning circuit

## 9.0 SAMPLE AND HOLD CIRCUIT

Sample and hold circuit can be defined as a device that acquires a signal and then stores it for a specified period of time before processing. It is recommended for optical tomography system because flow materials pass through sensor very fast resulting in more than a hundred varying sensors output voltage that need to be digitised. In addition, the circuit is useful to prevent data lost or wrong data captured per frame during instantaneous measurement.

## 10.0 DIGITAL SIGNAL CONTROL CIRCUIT

This circuit is to synchronise all system circuits with data acquisition system. It is very important in all of the optical tomography system that using data acquisition card because a good design will result in high data capture rate.

## 11.0 RESULTS

The optical tomography sensor that successfully developed by using parallel beam projection technique is shown in Figure 7. The cross-sectional images inside the figure are reconstructed by using the sensor developed and Hybrid image reconstruction algorithm.

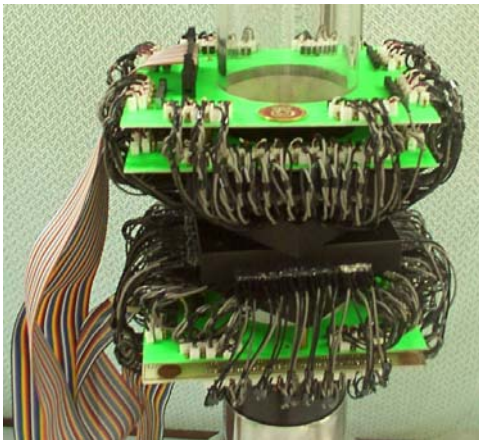

Optical tomography sensor

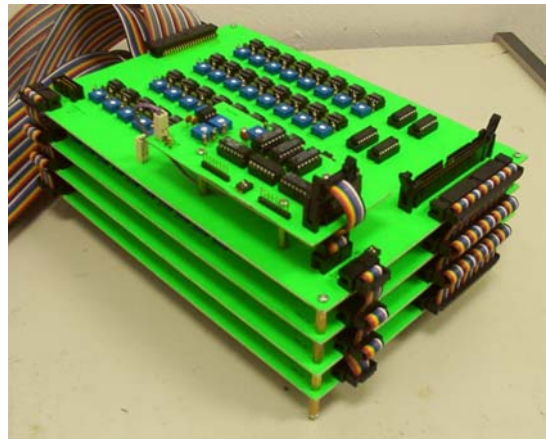

System circuits

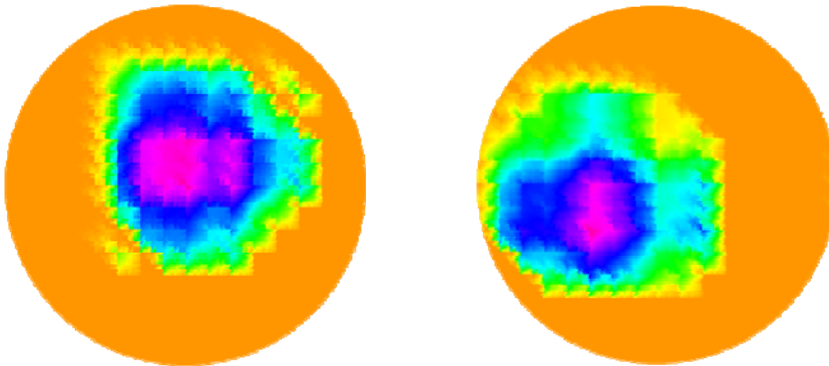

Cross-sectional images

**Figure 7** The developed optical tomography system

## 12.0 CONCLUSION

In conclusion, this paper has described the steps to construct an optical tomography system using 4 parallel beam projections. The success in the system development is surely beneficial to the further process measurement such as velocity and mass flow rate measurement.

## REFERENCES

- [1] Williams, R. A. and Beck, M. S. 1995. Introduction to Process Tomography. In: William, R. A. and Beck, M. S. (ed). *Process Tomography Principle Techniques and Applications*. Great-Britain: Butterworth-Heinemann. 3-12.
- [2] Ruzairi Abdul Rahim. 1996. *A Tomography Imaging System For Pneumatic Conveyors Using Optical Fibres*. Sheffield Hallam University. Ph.D. Thesis.
- [3] Sallehuddin Ibrahim, Green, R. G., Dutton K. and Ruzairi Abdul Rahim. 2000. Optical Tomography For Multi-Phase Flow. *WARSAW 2000*. T-15.
- [4] Chan Kok San. 2002. *Real Time Image Reconstruction for Fan Beam Optical Tomography System*. Universiti Teknologi Malaysia. M.Sc. Thesis.
- [5] Sallehuddin Ibrahim. 2000. Measurement Of Gas Bubbles in A Vertical Water Column Using optical Tomography. Sheffield Hallam University. Ph.D. Thesis.
- [6] Chan Kok San. 2001. *Image Reconstruction For Optical Tomography*. Universiti Teknologi Malaysia. B.Sc. Thesis.