

Factors Influencing Natural Frequencies in a Prestressed Concrete Panel for Damage Detection

L. D. Goh^{a,b*}, A. A. Rahman^a, N. Bakhary^a, B. H. Ahmad^a

^aFaculty of Civil Engineering, Universiti Teknologi Malaysia, 81310 UTM Johor Bahru, Johor, Malaysia

^bFaculty of Civil Engineering, Universiti Teknologi MARA, Malaysia

*Corresponding author: gohlyndee147@ppinang.uitm.edu.my; gohlyndee@yahoo.com

Article history

Received :10 March 2014

Received in revised form :

28 April 2014

Accepted :15 May 2014

Graphical abstract

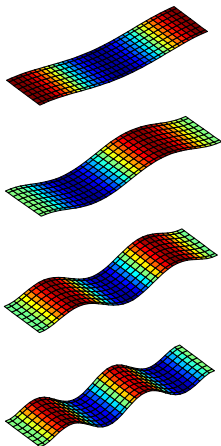

Abstract

Modal parameters such as natural frequencies, mode shapes, and damping ratios are widely used as damage indicators in the field of vibration-based damage detection. These modal parameters can be easily obtained by conducting the modal test on the actual structure or from the finite element model. However, many publications are focusing only on the relationship between the modal parameters and the changes in structural properties for damage detection. There are a limited number of publications discussing on the factors that may affect the modal parameters for damage detection. Hence, this paper provides a study on the level of influence of several factors on the natural frequencies of a prestressed concrete panel. The factors that are considered in this study are the size of element used in the numerical model, the dimension of the structural element, and the prestressing force applied in the prestressed concrete panel. The natural frequencies computed from the finite element model are also verified with the actual measured natural frequencies that are determined through the modal test conducted in the laboratory.

Keywords: Natural frequency; finite element model; modal test; prestressed concrete panel

© 2014 Penerbit UTM Press. All rights reserved.

1.0 INTRODUCTION

Modal parameters such as frequency response function, natural frequencies, damping ratios, and mode shapes are commonly used for the purpose of structural damage detection. Modal parameters are also known as structural dynamic properties. Many researchers have demonstrated that the changes in natural frequencies, mode shapes and/or damping ratios have been correlated with structural damages [1-5]. Hence, by assessing the dynamic properties of a structure from the vibration response, damage occurrence and its location can be identified. The damage severity information may also be determined using the appropriate damage assessment method.

The dynamic properties are determined from the experimental modal test conducted on the structures. In the experimental modal

testing, a dynamic signal analyser is used to record the input excitation and output response simultaneously. The modal parameters of interest could be extracted from the output responses of the experimental modal testing. The modal parameters are essential for damage detection procedures to assess if the structure under consideration has damaged, or if there are differences in damage levels or locations.

One of the early studies involving modal identification of a prestressed element is done by Allbright *et al.* [6]. The authors demonstrated the use of modal testing to determine the modal parameters of a damaged prestressed concrete beam. Chan *et al.* [7] conducted a modal test for a field measurement to determine the modal parameters for verification of the moving force identification study in a prestressed concrete bridge. In the proposed method, the authors computed the natural frequencies of

the bridge by converting the forces identified in time domain to frequency domain. Another study that applied modal test to verify the modal parameters was done by Miyamoto *et al.* [8]. The authors studied the effect of the prestressing technique using external tendons on the flexural vibration characteristics of a composite girder to the modal parameters. Next, Ren *et al.* [9] compared modal parameters for both experimental modal and analytical modal analysis of a steel girder arch bridge. In the study, experimental modal analysis was conducted with ambient vibration testing while a three-dimensional finite element model was used for analytical modal analysis. Other than that, an investigation was done by Unger *et al.* [10] on the changes of modal parameters in a gradually damaged prestressed concrete beam. Although the natural frequencies of the prestressed concrete beam reduced with the increasing load, the differences in frequencies and mode shapes were small as cracks closed again due to prestressing force. After the yielding point of the reinforcement, the modal parameters were more apparent than before the yielding had occurred.

In addition to that, Chung and Kim [11] identified the dynamic properties of spliced and monolithic prestressed concrete box railway girders using a modal test. The results were compared with three-dimensional finite element models. Similarly, in the recent study, He *et al.* [12] conducted the modal tests to study the dynamic properties of a three-span continuous prestressed concrete box girder bridge. The bridge was skewed at 45°. The experimental results were compared with those determined from analytical modal analyses. Maas *et al.* [8] studied on several experimental dynamic testing methods with different damage indicators for prestressed elements such as beams and slabs. The frequencies, damping, and mode shapes were used as damage indicators.

Previous studies involving prestressed elements were carried out using the modal parameters mainly for the purpose of damage detection. Most of the previous studies concentrated on correlating modal parameters to the changes in structural condition for both laboratory models and actual structures. On the other hand, a limited number of studies addressed the factors affecting the modal parameters for damage detection [14-15]. Lin *et al.* [16] investigated the effect of varying temperature to the modal parameters of prestressed beams and bridge. Lu and Law [17] conducted a study to determine the prestress force in a prestressed concrete bridge deck. The simply supported bridge deck was modelled as a continuous Euler-Bernoulli beam in the numerical model. The prestress force was modelled as an externally applied axial load. In the study, the modal tests were employed to validate the results from the numerical simulations.

Most of the aforementioned studies required a finite element model to assist in the damage detection procedures. The actual modal parameters determined from the experimental modal analysis conducted on the actual structure are commonly employed in the calibration of the modal parameters in the finite element model. However, to obtain reliable modal parameters either from the finite element model or from the actual model, it is necessary to understand and establish the variability of modal parameters due to factors affecting them. This paper presents an investigation on the level of influence of several factors on the natural frequencies in a prestressed concrete panel. The factors under investigation are the size of element used in the finite element model, the dimension of the actual structural element, and the prestressing force applied in the panel. Parametric studies have been carried out to study the influence of these factors on the computed natural frequencies. For verification purposes, an actual prestressed concrete panel is casted in the laboratory and a modal test has been carried out. The first four natural frequencies of the prestressed concrete panel are measured. The recorded natural frequencies are used to verify the natural frequencies obtained from the finite element model in the parametric study.

2.0 METHODOLOGY

2.1 Finite Element Model

The finite element model of a simply supported prestressed concrete panel was modelled using the Structural Dynamics Toolbox (SDT) that ran on MATLAB platform. The panel has a length of 2.7 metre, breadth of 0.7 metre, and thickness of 0.2 metre. To idealise the simple supports, all displacements were restrained along the global coordinate axis. The simple supports were located at 0.075 metre from both ends. There were a total of 333 nodes and 432 elements in the finite element model. Four nodes quadrilateral Mindlin shell elements were used in the model.

In the prestressed concrete panel, there were four units of prestressing strands as shown in Figure 1. The prestressing strands were idealised using pretensioned elements in SDT. The magnitude of the pretension force applied in the strands was 71.61 kN. The magnitude of the prestress force was determined from the design computation where 70% of allowable prestressing force was applied. The material properties of the slab for concrete were $E = 3.6 \times 10^{10}$ N/m², $\rho = 2456$ kg/m³, and $\nu = 0.2$, and for prestressing strands were $E = 2.0 \times 10^{11}$ N/m², $\rho = 7385$ kg/m³, and $\nu = 0.3$. Figure 2 illustrates the finite element model of the prestressed concrete panel.

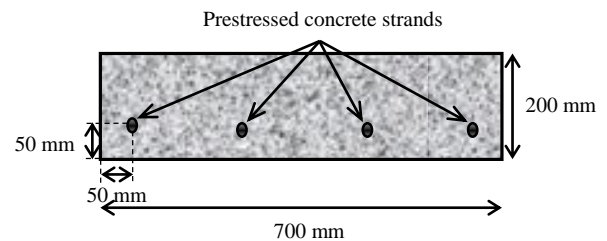

Figure 2 Cross-sectional view of the prestressed concrete panel

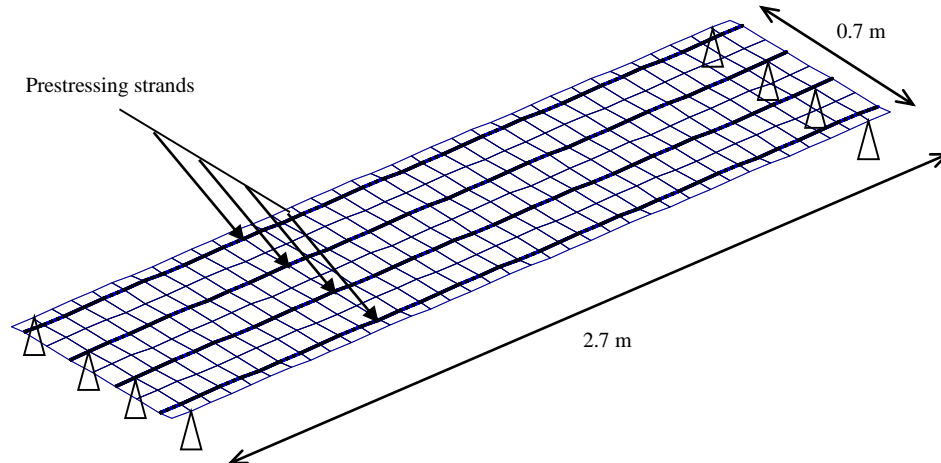

Figure 2 Schematic drawing of the prestressed concrete panel for finite element model



Figure 3 Conducting modal test on the prestressed concrete panel in the laboratory

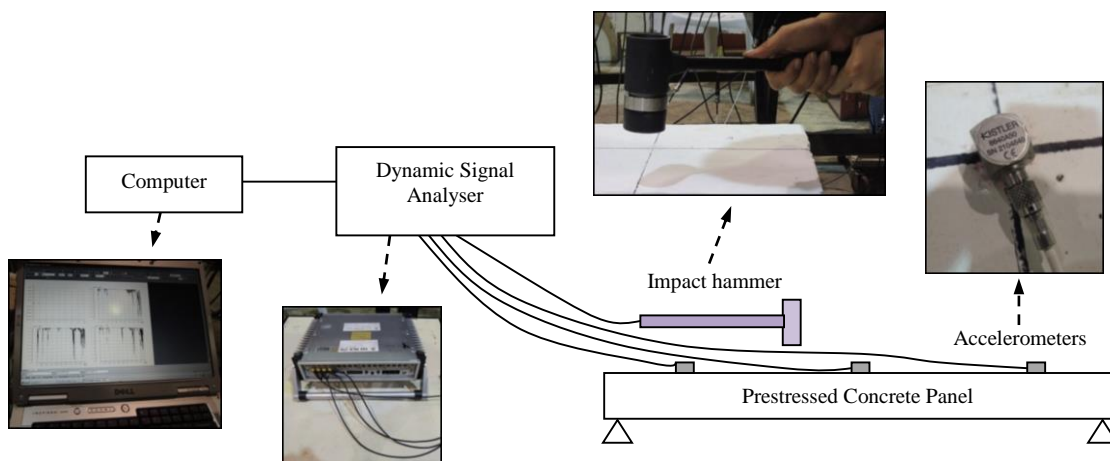

Figure 4 Test setup of the modal testing in the laboratory

2.2 Experimental Model and the Modal Test

A similar dimension of a prestressed concrete panel as modelled in the finite element model was constructed and casted in the

Structural Laboratory of Faculty of Civil Engineering in Universiti Teknologi Malaysia, Johor Bahru. There were four numbers of prestressed concrete strands of diameter 9.53 mm in the panel as mentioned in the previous section. The positions of

the strands as illustrated in Figure 1 and Figure 2. Each of the prestressed concrete strands was made of seven low relaxation high carbon steel wires with nominal steel area of 54.84 mm². The breaking load of the prestressing strands was 102.3 kN and the nominal weight was 0.405 kg/m. There was no reinforcement bar other than the prestressed concrete strands. The concrete grade was C50.

A modal test was conducted on the prestressed concrete panel to obtain the first four natural frequencies of the structure as depicted in Figure 3. One of the advantages of using modal testing is that vibrational characteristics are measured and used directly, thus computation of the mass and stiffness of the member is not required [6]. It is a common method of measuring the frequency response function (FRF) between one or more reference degrees of freedom and all the response degrees of freedom of interest. Subsequently, the modal parameters can be determined from the series of FRF.

The general test setup of the modal test is as depicted in Figure 4. An impact hammer (PCB Model 086D20) was used to excite the prestressed concrete panel. Acceleration responses of the prestressed concrete panel were measured using accelerometers (Kistler Model 8640A50). The responses were acquired using the Muller BBM-PAK through the PAK MK II system. Through the system, data from the time domain were transformed using fast Fourier transform into the frequency domain. The FRF was exported into a post-processing system to extract the modal parameters of interest, which in this study were the natural frequencies. The modal analysis was performed using the FRF imported from PAK MK II system into the software package ME'scopeVES to obtain the first four natural frequencies.

3.0 EXPERIMENTAL VERIFICATION

Based on the finite element model developed, the natural frequencies of the first four mode shapes of the prestressed concrete panel computed were 117.6 Hz, 310.6 Hz, 579.1 Hz and 906.2 Hz. The first four mode shapes of the finite element model are presented in Figure 5.

From the modal test conducted in the laboratory, the first four measured natural frequencies obtained were 108 Hz, 316 Hz, 574 Hz, and 889 Hz. To verify the computed frequencies, the actual measured frequencies obtained from the modal test of the prestressed concrete panel were employed for comparison. Table 1 tabulates the comparison results of the frequencies. From the table, it shows that the differences between the frequencies of the actual model and the finite element model are small with the maximum difference recorded is less than 9% in all four modes. The difference is calculated based on the actual model. This indicates that the finite element model prepared is valid in further parametric study. The minor discrepancies that are observed in the comparison of the natural frequencies between the finite element model and the actual model may be due to the factors under investigation in this paper.

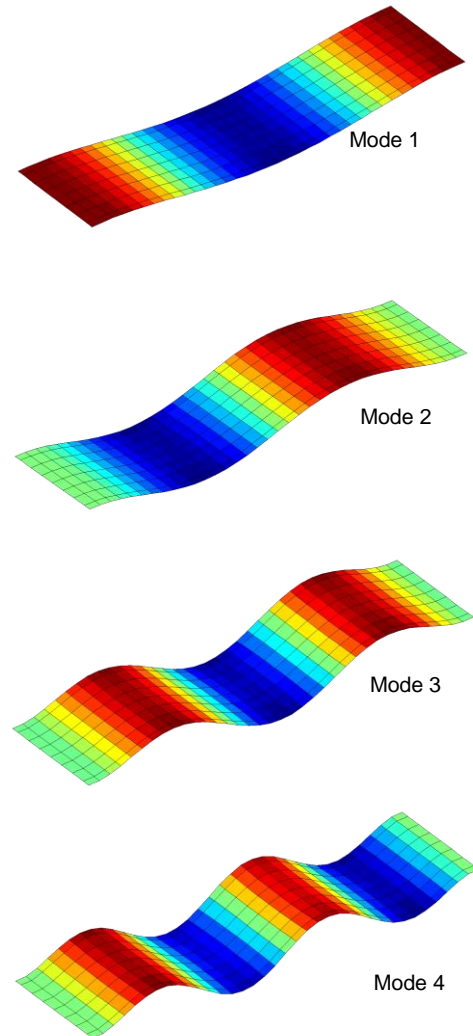

Figure 5 First four mode shapes of the prestressed concrete panel

Table 1 Natural frequencies of the actual and finite element models

Mode	Actual Model (Hz)	Finite Element Model (Hz)	Difference (%)
1	108	117.6	8.89
2	316	310.6	1.71
3	574	579.1	0.89
4	889	906.2	1.93

4.0 PARAMETRIC STUDY

To investigate the level of influential for the factors considered in this study, three different factors that may give influence to the natural frequencies were conducted in the parametric study. The factors are the effect of element size used in the finite element model, dimension of the structural element, and prestress force applied in the prestressing concrete strands.

Dimension in
Y-axis:
50, 6@100, 50

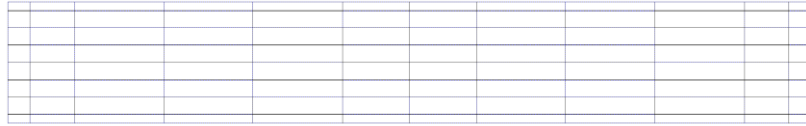

Dimension in X-axis: 75, 150, 3@300, 2@225, 3@300, 150, 75

All units in mm

Figure 6 Element sizes applied in Model A

Dimension in
Y-axis:
50, 6@100, 50

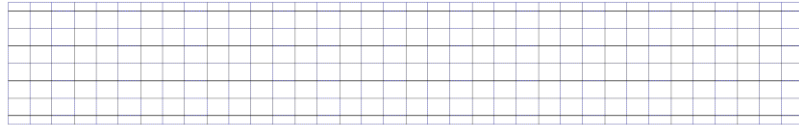

Dimension in X-axis: 36@75

All units in mm

Figure 7 Element sizes applied in Model B

Dimension in
Y-axis:
14@50

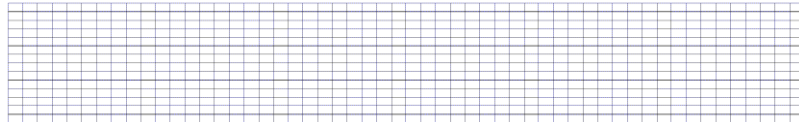

Dimension in X-axis: 54@50

All units in mm

Figure 8 Element sizes applied in Model C

Table 2 Frequencies of Model A, Model B and Model C (in Hz) and their percentage differences to actual panel

Mode	Model A	Difference	Model B	Difference	Model C	Difference
1	121.3	12.31%	117.6	8.89%	106.5	1.39%
2	337.1	6.68%	310.6	1.71%	283.8	10.19%
3	666.1	16.05%	579.1	0.89%	534	6.97%
4	1033	16.20%	906.2	1.93%	840.9	5.41%

4.1 Element Size in the Finite Element Model

Various researchers utilised different element sizes in the finite element model to discretise or mesh the complete model in their studies [18-21]. To investigate the importance of the selection of the element size in the finite element model, three element sizes were applied to the prestressed concrete panel model. Hence, there were three different models with different element sizes that were prepared for comparison purposes. The plan views of the three finite element models are as rendered in Figure 6, Figure 7, and Figure 8. For easier description, the models are named as Model A, Model B, and Model C, and the element sizes in the models are as described in the figures. The material properties and the boundary conditions for all the models are as described earlier.

The natural frequencies from the three different models were computed. Table 2 tabulated the natural frequencies and their difference compared to the actual measured natural frequencies. As can be seen from the table, Model A generally gives the least accurate results among the three models. This could be due to the coarse meshing applied in Model A. In comparison between Model B and Model C, Model B provides the natural frequencies closer to the actual panel by taking the average difference of the four modes. Thus, the findings in this section evidence that the element size employed in the numerical model gives significant effect of the modal parameters. Appropriate element size applied in the finite element model is crucial in order to obtain a precise result.

However, it should be noted that using a fine meshing in the finite element model will lead to a large number of elements and therefore a longer computation time and greater computation effort are required. On the other hand, using large element size may cause a localised damage in the structure to be neglected.

4.2 Effect of Structural Dimension

The effect of the structural dimension to the natural frequencies in the prestressed concrete panel was demonstrated in this section. Practically, the dimensions of the constructed structure are impossible to comply with the dimensions as stated in the construction drawings especially when concrete works are involved. Hence, in practice, according to British Standard [22], the ± 28 mm tolerances are allowable for in-situ or precast concrete slab. To study the effect of the dimension to the modal parameters, only the changes of thickness were considered in this study.

In this parametric study, the thickness of the panel was varied from 200 mm to 210 mm with every increment of 1 mm. The computed first four frequencies of panels are arranged in the Table 3. From the table, it is observed that the change of frequencies for every 1 mm is apparent. Thus, the actual dimension of the final constructed element is a very important parameter that affects the modal parameters.

The actual measurements of the dimensions of the actual prestressed concrete panel in the laboratory were collected. There were 28 points of measurements alongside the perimeter of the panel for the measurement of panel thickness. During the measurements on site, the actual panel thickness recorded a range of 195 mm to 210 mm. This indicates that there were discrepancies in the dimensions of the finite element model and the actual model. This may be one of the possible reasons that explains why there were differences in the computed and the measured natural frequencies. Similarly, there were also slight discrepancies in the measurements of the actual breadth and the length of the panel compared to the finite element model.

It is suggested that it is essential to consider the uncertainties as one of the important variations in vibration-based damage detection field to counter for the construction tolerances.

Table 3 Natural frequencies of different thicknesses in Hz

Thickness (mm)	Mode 1	Mode 2	Mode 3	Mode 4
200	117.6	310.6	579.1	906.2
201	118.2	311.9	581.3	909.3
202	118.7	313.2	583.5	912.3
203	119.3	314.5	585.7	915.3
204	119.8	315.8	587.8	918.3
205	120.3	317.1	590.0	921.2
206	120.9	318.3	592.1	924.2
207	121.4	319.6	594.3	927.1
208	122.0	320.9	596.4	930.1
209	122.5	322.2	598.5	933.0
210	123.0	323.5	600.6	935.9

4.3 Effect of prestress force

In this section, the effect of prestress force to the modal parameters was studied. In previous section, the prestress force applied in the finite element model and the laboratory model was taken as approximately 70% of the ultimate breaking load of the prestressing strand. This magnitude is the common magnitude that is applied in practice. As the breaking load of the prestressed concrete strand was 102.3 kN as given by the manufacturer, the recommended prestressing force used in the actual prestressed concrete panel was 71.61 kN.

To study the effect of the prestress force to the natural frequencies, a range of pretension force was assigned to the prestressing strand in the finite element model. The pretension force was applied at 100%, 70%, 50%, 30%, and 10% of the ultimate breaking load. The first four natural frequencies were computed in each prestress force case. The results are presented in Table 4. From the table, it is clearly evidenced that the prestress force does not give any significant effect to the modal parameters. There is only a minimal change of frequencies values between the modes. This concludes that the prestress force is not a significant factor that contributes to the changes of natural frequencies. In the study conducted by Allbright *et al.* [6], prestressing strand and prestressing force are not included in the finite element model as they do not affect the modal frequencies.

Table 4 Natural frequencies of models with different prestress. Force

	Percentage of ultimate breaking load				
	100%	70%	50%	30%	10%
	Prestress force (kN)				
	102.3	71.72	51.15	30.69	10.23
Mode 1	117.7	117.6	117.6	117.5	117.5
Mode 2	310.7	310.6	310.5	310.4	310.4
Mode 3	579.3	579.1	579.1	579.0	578.9
Mode 4	906.4	906.2	906.2	906.1	906.0

5.0 CONCLUSION

This study was carried out to achieve a better understanding of the levels of influence of several factors affecting the natural frequencies of a prestressed concrete panel. As the natural frequencies are one of the modal parameters that is useful in assessing damage, hence the consideration on factors affecting

the modal parameters should be taken into account for more reliable results. In this study, the finite element model was validated with the natural frequencies obtained from the actual model in the laboratory. From the parametric study, element size applied in the finite element model and dimensions of the actual model were found to greatly influence the modal parameters. However, varying the prestress force was found to have insignificant influence to the modal parameters. Thus, understanding and quantifying the variations in modal parameters are very crucial especially in practical applications. It is also suggested that the effects of uncertainties due to the finite element model and the measurements are essential in the structural damage detection.

Acknowledgement

The authors would also like to express their greatest gratitude to Eastern Pretech (Malaysia) Sdn. Bhd. for supplying the prestressed concrete strands in the study.

References

- [1] S. W. Doebling, C. R. Farrar, M. B. Prime, and D. W. Shevitz. 1996. Damage Identification and Health Monitoring of Structural and Mechanical Systems from Changes in Their Vibration Characteristics: A Literature Review. Los Alamos National Laboratory Report, LA-13070-MS.
- [2] R. P. C. Sampaio, N. M. M. Maia, and J. M. M. Silva. 1999. Damage Detection Using the Frequency-Response-Function Curvature Method. *Journal of Sound and Vibration*. 226: 1029–1042.
- [3] C. R. Farrar, S. W. Doebling, and D. A. Nix. 2001. Vibration-based Structural Damage Identification. *Phil. Trans. R. Soc. Lond.* 359: 131–149.
- [4] M. Sahin and R. A. Shenoi. 2003. Quantification and Localisation of Damage in Beam-like Structures by Using Artificial Neural Networks With Experimental Validation. *Engineering Structures*. 25: 1785–1802.
- [5] T. H. Ooijevaar, R. Loendersloot, L. L. Warnet, A. d. Boer, and R. Akkerman. 2010. Vibration Based Structural Health Monitoring of a Composite T-Beam. *Composite Structures*. 92: 2007–2015.
- [6] K. Allbright, K. Parekh, R. Miller, and T. M. Baseheart. 1994. Modal Verification of a Destructive of a Damaged Prestressed Concrete Beam. *Experimental Mechanics*. 34: 389–396.
- [7] T. H. T. Chan, S. S. Law, and T. H. Yung. 2000. Moving Force Identification Using an Existing Prestressed Concrete Bridge. *Engineering Structures*. 22: 1261–1270.
- [8] A. Miyamoto, K. Tei, H. Nakamura, and J. W. Bull. 2000. Behavior of Prestressed Beam Strengthened with External Tendons. *Journal of Structural Engineering*. 126: 1033–1044.
- [9] W. X. Ren, T. Zhao, and I. E. Harik. 2004. Experimental and Analytical Modal Analysis of Steel Arch Bridge. *Journal of Structural Engineering*. 130: 1022–1031.
- [10] J. F. Unger, A. Teughels, and G. D. Roeck. 2006. System Identification and Damage Detection of a Prestressed Concrete Beam. *Journal of Structural Engineering*. 132: 1691–1698.
- [11] W. Chung and S. M. Kim. 2011. Comparison of Dynamic Properties of Spliced and Monolithic Prestressed Concrete Box Railway Girders. *Engineering Structures*. 33: 1773–1780.
- [12] X. H. He, X. W. Sheng, A. Scanlon, D. G. Linzell, and X. D. Yu. 2012. Skewed Concrete Box Girder Bridge Static and Dynamic Testing and Analysis. *Engineering Structures*. 39: 38–49.
- [13] S. Maas, A. Zürbes, D. Waldmann, M. Waltering, V. Bungard, and G. D. Roeck. 2012. Damage Assessment of Concrete Structures Through Dynamic Testing Methods. Part 1 – Laboratory Tests. *Engineering Structures*. 34: 351–362.
- [14] S. Alampalli. 2000. Effects of Testing, Analysis, Damage, and Environment on Modal Parameters. *Mechanical Systems and Signal Processing*. 14: 63–74.
- [15] C. Farrar, S. W. Doebling, P. J. Cornwell, and E. G. Straser. 1997. Variability of Modal Parameters Measured on the Alamosa Canyon Bridge. In *Proceedings of XV International Modal Analysis Conference*. 257–263.
- [16] Y. Q. Lin, W. X. Ren, and S. E. Fang. 2011. Structural Damage Detection Based on Stochastic Subspace Identification and Statistical Pattern Recognition: II. Experimental Validation Under Varying Temperature. *Smart Materials And Structures*. 20: 115009.
- [17] Z. R. Lu and S. S. Law. 2006. Identification of Prestress Force from Measured Structural Responses. *Mechanical Systems and Signal Processing*. 20: 2186–2199.
- [18] J. Zhao, J. N. Ivan, and J. T. DeWolf. 1998. Structural Damage Detection Using Artificial Neural Networks. *Journal of Infrastructure Systems*. 4: 93–101.
- [19] J. M. Ko, Z. G. Sun, and Y. Q. Ni. 2002. Multi-Stage Identification Scheme For Detecting Damage In Cable-Stayed Kap Shui Mun Bridge. *Engineering Structures*. 24: 857–868.
- [20] J. J. Lee, J. W. Lee, J. H. Yi, C. B. Yun, and H. Y. Jung. 2005. Neural Networks-Based Damage Detection For Bridges Considering Errors In Baseline Finite Element Models. *Journal of Sound and Vibration*. 280: 555–578.
- [21] J. Min, S. Park, C. B. Yun, C. G. Lee, and C. Lee. 2012. Impedance-based Structural Health Monitoring Incorporating Neural Network Technique For Identification of Damage Type and Severity. *Engineering Structures*. 39: 210–220.
- [22] British Standard. 1990. Guide to Accuracy in Building. In *Problems Of Inaccuracy Or Fit Associated With Elements And Components Of Construction*. BS5606.