

An Experimental Study on Prototype Lightweight Brake Disc for Regenerative Braking

Shamsul Sarip^{a*}, Andrew, J. Day^b

^aUTM Razak School of Engineering and Advanced Technology, UTM Kuala Lumpur, Jalan Semarak, 54100, Kuala Lumpur, Malaysia

^bSchool of Engineering, Design and Technology, University of Bradford, West Yorkshire, BD7 1DP, U.K

*Corresponding author: shamsuls.kl@utm.my

Article history

Received :5 March 2014

Received in revised form :

6 January 2015

Accepted :15 March 2015

Graphical abstract

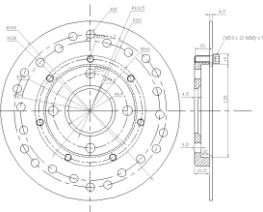

Abstract

Regenerative braking (RB) will minimize duty levels on the brakes, giving advantages including extended brake rotor and friction material life and, more significantly, reduced brake mass and minimised brake pad wear. Thermal performance was a key factor which was studied to measure disc surface temperature using chassis dynamometer in a drag braking with constant speed. The experimental work presented here to find friction coefficient and heat transfer coefficient, and evaluate temperatures for a ventilated brake disc and for a prototype lightweight disc using a Rototest chassis dynamometer. Heat transfer coefficient and friction coefficient of friction material can be determined from cooling analysis. The results from experiments on a prototype lightweight brake disc were shown to illustrate the effects of RBS/friction combination in terms of weight reduction. The design requirement, including reducing the thickness, would affect the temperature distribution and increase stress at the critical area. Based on the relationship obtained between rotor weight, and thickness, criteria have been established for designing lightweight brake discs in a vehicle with regenerative braking.

Keywords: Brakes; friction; chassis dynamometer; automotive; temperature; cooling; lightweight

Abstrak

Pembrekan jana semula dapat mengurangkan bebanan yang ditanggung oleh brek, kelebihan ini secara tidak langsung dapat pemanjangan jangka hayat bagi rotor brek dan pad brek, lebih penting lagi, dapat mengurangkan jisim brek serta kadar kehausan pad brek. Prestasi terma merupakan faktor utama dalam kajian ini di mana digunakan sebagai aras ukuran bagi suhu permukaan cakera melalui kaedah seretan brek dengan kelajuan malar dengan menggunakan casis dinamometer. Kerja ujikaji dijalankan untuk mencari pekali geseran dan pekali pemindahan haba, serta menilai kenaikan suhu bagi cakera brek ventilasi dan cakera brek prototaip ringan dengan menggunakan Rototest casis dinamometer. Pekali pemindahan haba dan pekali geseran bagi pad brek boleh ditentukan melalui analisis penyejukan. Hasil ujikaji ke atas prototaip cakera brek ringan dapat digambarkan melalui kombinasi RBS / geseran dari segi pengurangan berat. Keperluan kepada reka bentuk dengan mengurangkan ketebalan, akan menjejaskan aliran suhu dan seterusnya akan meningkatkan tekanan di kawasan kritikal. Berdasarkan kepada hubungan antara berat rotor, dan ketebalan, maka kriteria rekabentuk cakera brek ringan dapat diperolehi dengan mereka bentuk cakera brek ringan bagi kegunaan di dalam kenderaan pembrekan jana semula.

Kata kunci: Brek; geseran; casis dinamometer; automotif; suhu; penyejukan; ringan

© 2015 Penerbit UTM Press. All rights reserved.

1.0 INTRODUCTION

Energy recuperated from a regenerative braking (RB) depends on the size of the motor/generator (M/G); the bigger the size the more electric power will be produced, but high braking torque during braking could lead to wheel lock [1-2]. A suitable M/G size was 40 kW for use in a medium-sized passenger car with a mass of between 1000 kg and 1500 kg based on the calculation.

This power is for a constant speed on a flat road, at lower speeds, or driving in urban areas in which the average load power is much lower. When braking, the 40 kW M/G itself could provide the required brake torque without friction brake (FB) to slow down the vehicle at decelerations under 0.4 g and could be recuperated from 30% up to 45% of the total braking energy in a single-stop braking situation depending on the system efficiency. However, when the vehicle deceleration is higher than 0.4 g, the FB has to

provide the required vehicle deceleration. Using a 40 kW M/G gives low duty to the FB and potentially requires small FB or reduction in mass of the standard brake to a lighter brake disc [3].

Aluminium has a lower density than cast iron and stainless steel. Cast aluminium and aluminium-based metal matrix composites (MMC) have been proposed for brake discs and drums in recent years [4]. An aluminium MMC describes a type of lightweight high-performance aluminium alloys/composites. The weight benefits of Aluminium MMC disc brake can be as much as 45-61% [5]. Thermal conductivity of this material is much higher, and it is capable of rapidly conducting heat from the friction surface. However, Al-MMC has not been studied in this research because it has a low maximum operating temperature (MOT) at 450°C; it is thus too soft, leading to poor wear resistance, and is generally unsuitable for use in road vehicles.

The thermal stability of the brake system is primarily ensured by the correct design of the brake discs. The heat storage capacity (thermal mass) of the brake disc has a considerable effect on the behaviour of the brake caliper. Based on the previous analysis the available RB energy ranges from 30% to 87% on the front wheels and the duty level of FB in a car with RB is estimated to be low [2, 6]. The maximum braking power of FB is predicted to be in the range from 15 kW to 78 kW for a typical road car [7]. This paper presents a prototype lightweight disc rotor and results of testing to compare the brake temperature behaviour between prototype solid disc and ventilated disc. The experimental setup for determining the cooling prototype and ventilated discs is also presented which enables the heat transfer coefficient from the exposed surface of a brake rotor to be evaluated. The goals of this paper was to investigate ways of reducing vehicle mass and thus fuel consumption by focusing on a new design of lightweight brake for car with regenerative braking.

1.1 Single Stop Temperature Calculation

Brake application assuming the total vehicle KE is transformed into heat based on single stop temperature rise (SSTR) calculation [8] during a stop from maximum speed of 27.7 m/s at 0.4 g: Total kinetic energy at each front disc for vehicle mass, $m = 1495$ kg.

$$KE = \frac{1}{2} MV^2 \times 0.5 \times X_I \times c \times (13\% \text{ duty level of FB or } 87\% \text{ FB energy recuperated with RB}),$$

$$KE = 0.5 \times 1495 \times 27.7^2 \times 0.5 \times 0.8 \times 1.05 \times 0.13 = 31 \text{ kJ}$$

and for 70% duty level of FB or 30% energy recuperated with RB,

$$KE = 0.5 \times 1495 \times 27.7^2 \times 0.5 \times 0.8 \times 1.05 \times 0.7 = 169 \text{ kJ}$$

Temperature rise ΔT was calculated using equation,

$$KE = mC_p\Delta T \tag{1.1}$$

The temperature rise at each brake disc (DT) for the FB with RB on the front wheels is 16°C, this refers to 87% of energy recuperated. In comparison $\Delta T = 88^\circ\text{C}$ for 30% of energy recuperated with RB [2]. Taking the disc ring mass, m as 3.5 kg and $C_p = 550 \text{ J/kgK}$, the braking force generated at the front brake disc for $J = 0.4 \text{ g}$ (3.9 m/s^2 at GVM) was predicted as the maximum energy recuperated at 87% equal to 13% of friction brake duty:

$$F_b = MJ \times X_I \times \frac{1}{2} \times c = 1495 \times 3.9 \times 0.8 \times 0.5 \times 1.05 \times 0.13 = 318 \text{ N}$$

and the calculated brake torque is:

$$\tau = \mu 2PA_p r_{eff} = F_b \times R_r = 318 \times 0.291 = 93 \text{ Nm}$$

From these torque estimates the temperature rises for FB with 13% and 70% brake duty can be calculated and compared to typical values of single stop temperature range (SSTR) shown in Table 1, which can be considered as the MOT for a typical brake used without RBS. Refer to Curry [8], of this study for the SSTR calculations.

Table 1 Typical values for the thermal design. Adapted from Curry [8]

Rotor	SSTR (°C)
Drum	350 – 400
Solid disc	550
Vented disc	600 - 650

1.2 Prototype Lightweight Disc Rotor

A prototype lightweight disc assembly was designed (Figure 1) based on the design method [9]. It comprised two parts; a friction ring and a hub adaptor. The friction ring was made of stainless steel, it had 24 cross-drilled hole to improve cooling and was bolted to the adaptor which was also made of stainless steel. The standard callipers on the test car were used but required piston spacers as shown in Figure 2. The disc thickness was 4.9 mm had 260 mm outside diameter and 146 mm inside diameter. The total mass was 3.2 kg including the adaptor. The swept area of the disc was 0.07 m² calculated based on the outer (256 mm) and inner dimensions (146 mm) of the brake pad. The disc exposed surface area is 0.104 m² was used to calculate the cooling rate and convective heat dissipation.

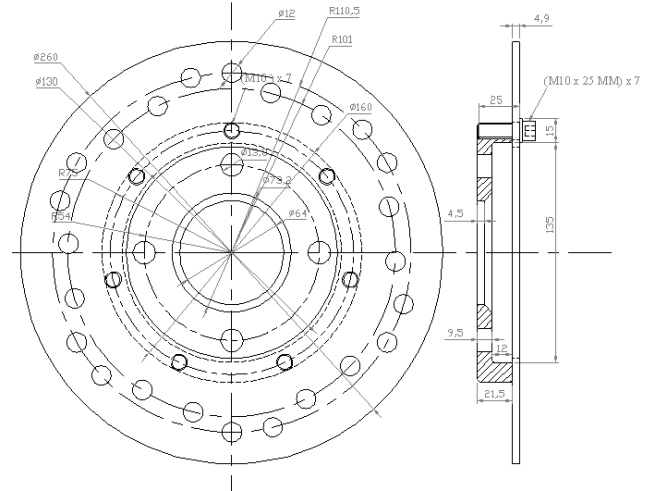

Figure 1 Prototype disc geometry

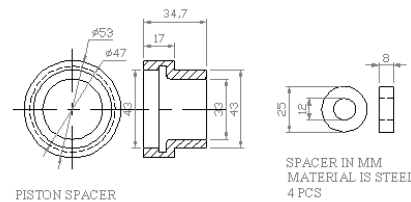

Figure 2 Piston spacer and spacer for the standard caliper

The prototype lightweight brake disc was based on the friction brake lower duty in a vehicle with RBS. The key objective was to investigate the disc thermo mechanical capabilities of a prototype lightweight disc. The disc/hub was not

investigated or optimised. There may be limitations of high temperatures in the prototype disc, but the important aspect was to investigate a way of reducing vehicle mass.

2.0 METHODOLOGY

A standard ventilated disc was tested on the chassis dynamometer to measure the temperature distribution on the disc friction surface using rubbing thermocouples connected through a data logger. The chassis dynamometer, known as a Rototest Energy chassis dynamometer, is a direct-drive axle type in which there is no slip between the tyre and the dynamometer. The system also has low inertia and an accurate measuring.

The chassis dynamometer measures wheel torque under different drive simulation conditions. It comprises a motor unit, a drive and main power supply cabinet, a controller, PC and real-time data logger analysis and cabling. The maximum power that can be absorbed and generated is 100 kW, maximum torque is 2500 Nm (instantaneous) and 1180 Nm (continuous), maximum hub speed is 2100 rpm equivalent to a maximum vehicle speed of 250 km/h. The dynamometer simulation capabilities include standard driving cycles such as ECE/EG, US06, and FTP75 [10]. The temperatures were measured through the rubbing thermocouples connected through the data logger. The pressures and the torques were measured through the corresponding transducers fitted in the dynamometer. The drag braking test was carried out on both discs with one rubbing thermocouple on the disc surface, one to the top hat (hub), and a third thermocouple which was attached to the front wheel hub.

The test car (approximate vehicle mass 1495 kg) was mounted to the chassis dynamometer. The wheel rotational was set at constant speed of 30 km/h to allow the new friction materials and the new discs to become well bedded-in. Each brake pad was weighed and its thickness measured before starting each experiment. The thickness was measured using a coordinate measuring machine (CMM); the back plate surface was measured at 4 points and then 16 points on the friction surface as shown in Figure 3. The machine software (Inspect-3D) calculated the thickness at each point on the friction surface. By measuring the friction materials' weight and area of contact before and after the experiment, the wear thickness could be calculated.

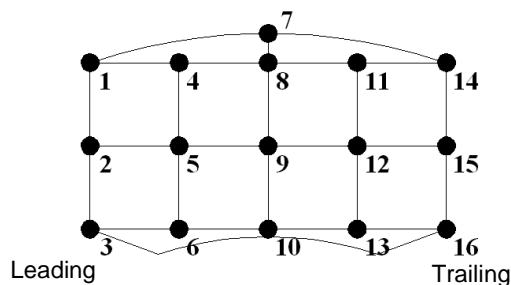

Figure 3 Location of '16 points' on friction materials on near side wheel (outside)

2.1 Brake Cooling

Newton's Law of cooling was applied, which states that heat loss is proportional to the temperature difference between the cooling body and its surroundings [11]. The heat dissipated by convection is determined by the following equation,

$$q = hA_s(T - T_\infty) \quad (1.2)$$

The heat energy absorbed by the disc is given by

$$KE = mC_p\Delta T, \text{ where } \Delta T \text{ is temperature rise } (^\circ\text{C}). \quad (1.3)$$

time constant for cooling is β , Sakamoto [11] from Newton's Law of cooling.

$$\beta = (mC_p)/hA, \text{ where } A \text{ is area and } A_s \text{ is surface area.} \quad (1.4)$$

From equation (1.4) the heat transfer coefficient, h can be calculated,

$$h = mC_p/\beta A \quad (1.5)$$

The heat transfer coefficients were calculated after 100 brake applications for both discs. The measured value of heat transfer coefficient was 94 W/m²K (ventilated) and 75 W/m²K (prototype). Both experiments were conducted at the same room temperature at 13°C with air coming from a cooling fan located one metre distance away from the car with air velocity about 3.5 m/s. The results show that the prototype lightweight disc can transfer heat almost as well as the standard ventilated disc.

3.0 ANALYSIS AND RESULTS

A significant difference was in the temperature rise of the two disc types. For the prototype lightweight disc the temperature rise was a maximum of 260°C compared with 160°C for the standard ventilated disc (both discs were tested by the same procedure). The relationship between temperature change and heat energy change is governed by the specific heat; the specific heat of stainless steel is 460 J/kgK which is lower than cast iron (550 J/kgK). Ideally a brake should be made from a material with a high specific heat to give a smaller temperature rise for a given amount of energy transferred into the brakes. A small temperature rise means the brakes are less heavily thermally loaded.

3.1 Standard Ventilated Disc

An example temperature profile plotted against time is shown in Figure 4. The maximum temperature rise recorded was 1°C after 20 bar brake fluid pressure was applied for 10 seconds. The temperature at the disc hat showed an increase of 3.9°C, typically from 76.5°C to 80.4°C in approximately 54 seconds. After the brake was released no further temperature increase was noted at the wheel axle, and the disc began to cool down from 159°C to 100°C in approximately 137 seconds.

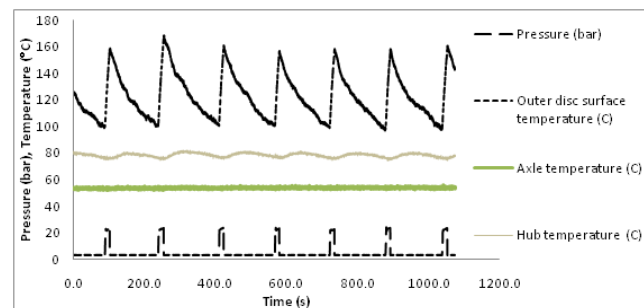

Figure 4 Time series data of drag braking

The heat transfer was calculated as $1/\beta$ is $3.70 \times 10^{-3} \text{ s}^{-1}$ giving a time constant β of 270 seconds and the resulting value

of the heat transfer coefficient is 94 W/m²K; as shown in the following calculation below.

Calculation of heat transfer coefficient using Equation 1.4: for the test car ventilated disc, m = 5.23 kg, and the total disc exposed area A = 0.113 m², from the heat transfer calculation, 1/β = 3.70 × 10⁻³ s⁻¹ unit so

$$\beta = 270 \text{ seconds giving } h = 94 \text{ W/m}^2\text{K}$$

The average heat transfer coefficient from 6 runs shown in Table 2 indicated that the average cooling rate on the standard ventilated disc surface with the cooling fan was 90 W/m²K.

Table 2 Heat transfer coefficient

Run 1	86.5	W/m ² K
Run 2	94.0	W/m ² K
Run 3	89.1	W/m ² K
Run 4	86.5	W/m ² K
Run 5	89.1	W/m ² K
Run 6	94.0	W/m ² K
Average	90.0	W/m ² K

The value of friction coefficient, μ can be calculated. The friction coefficient was calculated from the formula [9];

$$\mu = \frac{\tau}{2\eta p A_p r_{eff}} \tag{1.6}$$

The average friction coefficient calculated for the friction material in contact with the standard ventilated disc was 0.41 (within the range of dry sliding) [12]. The friction coefficient slightly increased and then remained constant as shown in Figure 5.

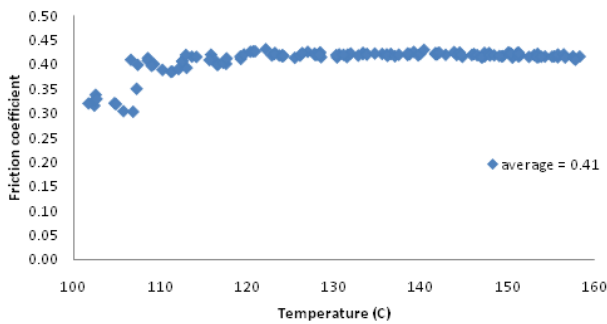

Figure 5 Calculated friction coefficient of ventilated disc

3.2 Prototype Lightweight Disc

The prototype lightweight disc was made of stainless steel and bolted to the hub as a complete thin solid disc. The disc's exposed surface area was 0.104 m². The type of friction material used in the experiment was a standard non-asbestos organic (NAO).

Friction material wear was plotted before and after the drag braking test for both pads on the near side wheel (Figure 6 and Figure 7). Table 3 and Table 4 are examples of the different thickness layers of the near side friction material. From the two

graphs, two layers were plotted. The first layer is for the new pad measured on 16.12.2010 (Test 1), The second layer with the same pad after the drag braking test was measured on 19.01.2011 (Test 2). Both friction materials show the wear profile at different locations of leading and trailing edges of the friction material. The lowest layer is shown in Figure 6, after the shape has been changed to form a sloping surface. This is because of the high disc temperatures in drag braking which encourage disc thermal coning.

Table 3 Friction material thickness (outside) in mm for near side wheel

Test 1		7		13.627					
1	13.48	4	13.536	8	13.553	11	13.55	14	13.538
2	13.248	5	13.278	9	13.291	12	13.298	15	13.294
3	12.943	6	12.942	10	12.978	13	12.981	16	12.978
		1	2	3	4	5			

Test 2		7		13.418					
1	13.303	4	13.337	8	13.356	11	13.362	14	13.343
2	13.081	5	13.079	9	13.085	12	13.102	15	13.076
3	12.852	6	12.838	10	12.832	13	12.832	16	12.847

Trailing edge 1 2 3 4 5 Leading

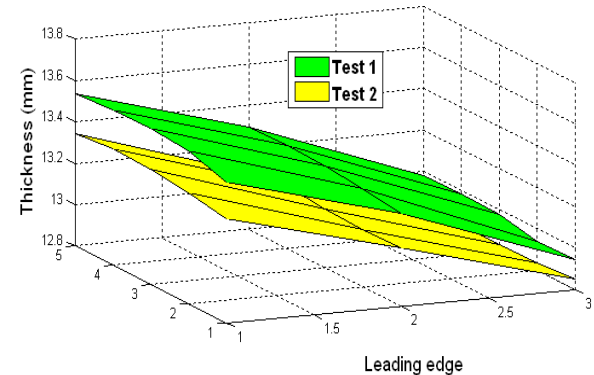

Figure 6 Layers of friction material wear for near side (outside)

Table 4 Friction material thickness (piston side) in mm for near side wheel

Test 1		7		13.139					
1	13.042	4	13.063	8	13.069	11	13.06	14	13.031
2	12.798	5	12.819	9	12.826	12	12.824	15	12.783
3	12.581	6	12.545	10	12.574	13	12.556	16	13.58
		1	2	3	4	5			

Test 2		7		12.865					
1	12.861	4	12.825	8	12.799	11	12.806	14	12.758
2	12.707	5	12.669	9	12.631	12	12.617	15	12.592
3	12.531	6	12.535	10	12.566	13	12.473	16	12.471

Trailing edge 1 2 3 4 5 Leading edge

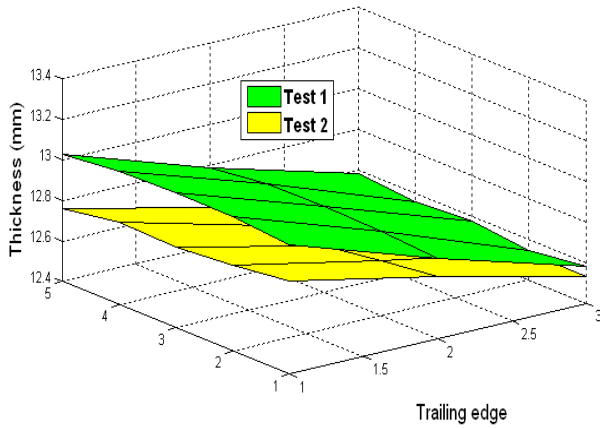

Figure 7 Layers of friction material wear for near side (piston side)

Table 5 Friction material masses of near side and off side wheel. Friction material density, $\rho = 2620 \text{ kg/m}^3$, and friction area, $A_p = 3.53 \times 10^{-3} \text{ m}^2$

Near side wheel			
	Test 1	deviations	Test 2
	Mass (gram)	Mass (gram)	Mass (gram)
Piston side	343.5	0.7	342.8
Outside	330.3	0.7	329.6
Off side wheel			
Piston side	347.0	0.6	346.4
Outside	330.1	0.6	329.5

The prototype brake disc as shown in Figure 8 explaining the layout of measuring disc surface temperature. The measured friction ring temperatures rose from 100°C to a maximum of 250°C in 10 seconds of braking using about 20 bar of applied hydraulic pressure (Figure 9). In one particular cycle, the brake pedal was applied to 20 bar line pressure and hold for 10 seconds, the temperature increased from 100°C up to 257°C. Once the brake was released, the disc temperatures kept increasing to reach 271°C in 5.6 seconds before dropping. This is because thermal energy is transferred to another region. The disc was allowed to cool down to a nominal temperature which is 100°C. In this cycle, the prototype lightweight disc needed 158 seconds to cool down from 257°C to 100°C.



Figure 8 Rubbing thermocouple on the hub of the prototype lightweight disc with a dial gauge to indicate the disc coning deflection

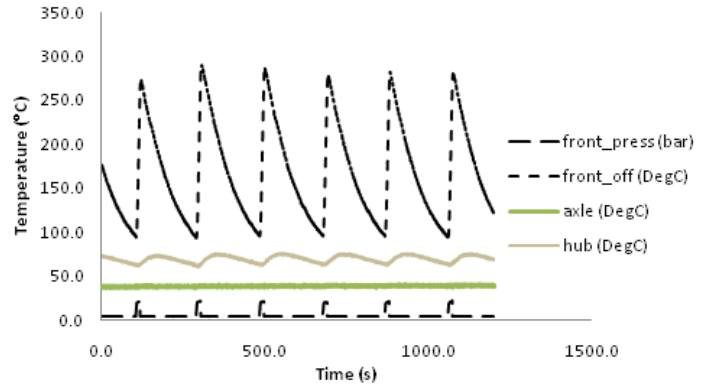

Figure 9 Temperatures and pressure measurement on the off-side front wheel prototype lightweight disc

The surface temperatures of the hat section increased from 61°C to 63°C in 10 seconds and continued climbing to 73°C before decreasing gradually to 61°C. The axle temperature did not change over the brake application of 10 seconds’ duration of single stop braking. Hence, this shows that, in a short braking time, the bearing in the wheel axle would not experience any significant temperature rise.

The disc cooled quickly at first while hot and the rate of cooling slowed down gradually as the temperature of the disc approached the ambient temperature. The maximum temperature recorded was 275°C. The temperature cooled down to 100°C in 171 seconds with a constant wheel speed of 273 rev/min. Figure 10 shows the comparison between the prototype lightweight disc and the standard ventilated disc under constant speed drag braking. The prototype lightweight disc was thinner than the ventilated disc, and showed a greater temperature increase of approximately 120°C.

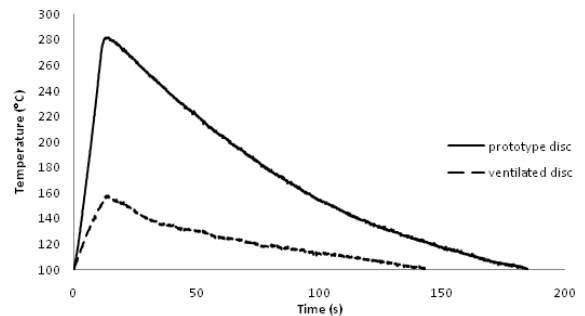

Figure 10 Short drag braking temperature rise comparison

The ambient temperature was 13°C. Figure 11 shows the experimental results of the cooling rate, $1/\beta$, used to calculate heat transfer coefficient for both discs. The prototype lightweight disc mass was 3.2 kg and the standard ventilated disc was 5.3 kg; the exposed surface areas were 0.104 m² and 0.113 m² respectively. The cooling rate of the prototype lightweight disc was calculated as 0.0053s⁻¹ and for the standard ventilated disc it was 0.0037s⁻¹. Using Equation 1.4, the convective heat transfer coefficient for the prototype lightweight discs was 75 W/m²K, and for the standard ventilated disc it was 94 W/m²K.

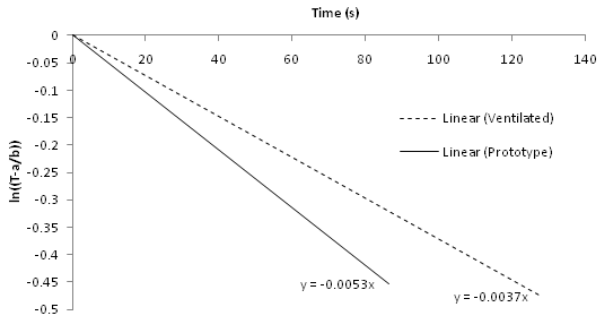

Figure 11 Convective heat dissipation calculation on prototype lightweight disc and standard ventilated disc

The friction coefficient of the standard friction material (NAO) was calculated based on Equation 1.6. From the graph in Figure 12, the average friction calculated for the prototype lightweight disc with NAO friction material was 0.37 whereas for a standard ventilated disc made of cast iron in contact with NAO it was 0.41. The results show good correlation with the previous observation that cast iron has a higher friction coefficient than stainless steel against certain types of standard friction material [13-15].

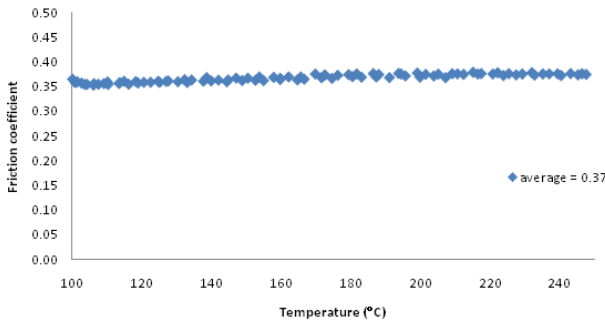

Figure 12 Friction coefficient with prototype brake disc

After 100 brake applications on the prototype disc, it was found that the disc displayed signs of ‘blue spotting’, indicating that it had been exposed to high temperatures (Figure 13). This situation may be created by high temperature or by brake system imbalance. Evidence of ‘blue spotting’ means that the disc should be inspected to make sure it is not damaged e.g. cracked. If this situation is left unchecked it can result in martensite transformation and eventual cracking.



F.13a Standard ventilated disc (Before and After)



F.13 b Lightweight prototype disc (Before and After)

Figure 13 Hot spots occurring after 100 brake applications F.13a and F.13b

4.0 DISCUSSION

The prototype disc was made of stainless steel, which has a high tensile strength, and shows lower disc coning compared to cast iron. However, in terms of temperature distribution, stainless steel shows better thermal properties compared to cast iron. This is because stainless steel has a lower thermal conductivity and heat capacity in order to absorb and transmit the heat generated at the friction interface. Stainless steel was thus suitable for use for a lower braking duty because it has a lower heat transfer coefficient and heat capacity in order to absorb and transmit the heat generated at the friction interface.

Temperature measurements have been carried out on both prototype lightweight discs and ventilated discs on the chassis dynamometer. There are many types of temperature measuring systems for use on disc brakes, such as infrared thermoscanners, embedded thermocouples, and rubbing thermocouples. Here rubbing thermocouples were used to measure the friction surface temperature of the brake discs. They are suitable for measuring brake disc temperatures as they gave accurate readings, were easy to use, low cost, robust, and low maintenance.

A chassis dynamometer was used to test the prototype lightweight and ventilated disc. The advantages of using the chassis dynamometer were its low inertia and accurate torque measurement. An experiment was also conducted to predict a heat transfer coefficient, for the prototype lightweight and the standard ventilated disc and then the heat transfer coefficient was used as a boundary condition in the FEA. There were some disadvantages of using the Rototest: it needed quite a long time to install the wheel adapter to the vehicle, an assistant to install it, and a large space and flat hard surface area.

The experimental results of the prototype lightweight disc produced a greater cooling rate but higher maximum temperature. The cooling rate was greater because of the exposed surface area. The mass of the prototype lightweight disc was about half that of the ventilated disc, therefore, it had about twice the temperature increase of the ventilated disc.

5.0 CONCLUSION

It can be concluded that stainless steel is a suitable material for a lightweight brake disc in terms of mechanical and thermal strength, provided that the tribological characteristics are suitable (e.g. it might be advantageous to use different pad materials). Stainless steel is suitable to be used for disc thicknesses less than 8 mm because stainless steel has three times the tensile strength of cast iron [16]. For disc thicknesses of 8 mm or greater cast iron is suitable because of its high thermal conductivity and low Young's modulus, which limit the amount of disc damage caused by the heat flux generated by friction.

The heat capacity of the material has been shown to be as significant as the thermal conductivity. Disc material with higher heat capacity can decrease both the maximum surface temperature and the maximum stress applied to the disc surface. But stainless steel seems to be a good material for a lightweight disc, and it is better than Al-MMC because of its higher MOT. A disc made of stainless steel is designed to minimise stresses and distortion.

Acknowledgement

The author would like to thank the Universiti Teknologi Malaysia for funding this project. Author is a member of IACSIT, International Association of Engineers, SAE International, Board of Engineers Malaysia, and The Institution of Engineers Malaysia. Sincere appreciation to School of Engineering, Design and Technology University of Bradford in making this study accomplished.

References

- [1] Ehsani, M., Y. Gao, and A. Emadi. 2009. *Modern Electric, Hybrid Electric, and Fuel Cell Vehicles: Fundamentals, Theory, and Design*. Second Edition ed. New York: CRC Press. 534.
- [2] Sarip, S.B., et al. 2011. Lightweight Friction Brakes for a Road Vehicle with Regenerative Braking: Design Analysis and Experimental Investigation of the Potential for Mass Reduction of Friction Brakes on a Passenger Car with Regenerative Braking. 2011: University of Bradford.
- [3] Sarip, S. 2013 Design Development of Lightweight Disc Brake for Regenerative Braking and Finite Element Analysis. *International Journal of Applied Physics and Mathematics*. 3: 52–58.
- [4] Barton, D.C. 2008. Materials Design for Disc Brakes. In *Braking of Road Vehicles 2008*.
- [5] Huang, S. X. and K. Paxton. 1998. A Macrocomposite Al Brake Rotor for Reduced Weight and Improved Performance. *JOM. (Innovations in Aluminium, Part IV)*. 26.
- [6] Gao, Y., L. Chen, and M. Ehsani. 1999. *Investigation of the Effectiveness of Regenerative Braking for EV and HEV*. SAE International. 1999-01-2910.
- [7] Wang, F. and B. Zhuo. 2008. Regenerative Braking Strategy for Hybrid Electric Vehicles Based on Regenerative Torque Optimization Control. Proc. IMechE Part D: *J. Automobile Engineering*. 222: 499–513.
- [8] Curry, E. 2008. Design, Installation and Production of Brake Rotors. *Braking of Road Vehicles*. 128–169.
- [9] Sarip, S. B. 2011. Lightweight Friction Brakes for a Road Vehicle with Regenerative Braking. In *Engineering, Design and Technology*. Bradford University. 245.
- [10] Rototest. 2009. Rototest Manual Version 1.0: Ronninge, Sweden.
- [11] Sakamoto, H. 2000. Heat Convection and Design of Brake Discs. Proceedings of the Institution of Mechanical Engineers Part F. *Journal of Rail and Rapid Transit*. 218(3): 203–212.
- [12] Blau, P.J. and J.C. McLaughlin. 2003. Effects of Water Films and Sliding Speed on the Frictional Behavior of Truck Disc Brake Materials. *Tribology International*. 36: 709–715.
- [13] Yuen, D. K. K. 1992. Brake Disc Life Prediction for Material Evaluation and Selection. In *Mechanical and Manufacturing Engineering*. University of Bradford. 275.
- [14] Bakar, A., et al. 2006. A New Prediction Methodology for Dynamic Contact Pressure Distributions in a Disc Brake. *Jurnal Teknologi A*. (45A): 1–11.
- [15] Abdul Hamid, M. and G. Stachowiak. 2012. Effects of External Hard Particles on Brake Friction Characteristics During Hard Braking. *Jurnal Teknologi*. 58(2).
- [16] Gere, J. M. and S. P. Timoshenko. 1999. *Mechanics of Materials*. Stanley Thornes.