

# Antilock Braking System Using Dynamic Speed Estimation

Fargham Sandhu<sup>a</sup>, Hazlina Selamat<sup>a\*</sup>, Yahaya Md Sam<sup>b</sup>

<sup>a</sup>Centre for Artificial Intelligence & Robotics, Universiti Teknologi Malaysia, 81310 UTM Johor Bahru, Johor, Malaysia

<sup>b</sup>Faculty of Electrical Engineering, Universiti Teknologi Malaysia, 81310 UTM Johor Bahru, Johor, Malaysia

\*Corresponding author: hazlina@fke.utm.my

## Article history

Received :15 June 2014

Received in revised form :

15 September 2014

Accepted :15 October 2014

## Graphical abstract

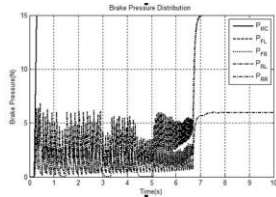

## Abstract

Antilock braking systems use slip to control braking, for which the velocity of the car and wheel speeds of the wheels are required. The wheel speeds can be measured directly but the velocity of the vehicle is difficult to measure. Although the wheel speed can be used to calculate the linear velocity of the vehicle using the tire characteristic function, it depends upon various environmental and time varying parameters. The dominant factor in the characteristic function is the road friction coefficient. Due to the difficulties in proper estimation of the road friction, most systems calculate the optimal values offline and apply them at different speeds using switching functions. By using the tire model and the optimal friction coefficients, the velocity of the vehicle is estimated and used for calculating the optimal braking force, resulting in inappropriate control of braking creating longer braking distances. In the method proposed in this paper, an estimator will be used to estimate the velocity, which is proved to be more accurate than calculated from the wheel speeds. The estimated velocity and the pitch angle will be used to schedule the braking forces in order to reduce the braking time. The braking time of the proposed system lies between the ideal braking time and the conventional reference wheel speed related braking time, indicating an improvement in reducing the braking distance.

**Keywords:** Slip; complementary filter; kinematic model; split mu system; kalman filter

© 2015 Penerbit UTM Press. All rights reserved.

## 1.0 INTRODUCTION

During travel, the automobile experiences several forces. Some of these forces are due to the weight of the vehicle while others are due to the traction of the engine and braking. All these forces are reflected to the tires to create friction. The traction forces, weight and momentum related forces have components along the longitudinal, lateral and vertical axis of the vehicle. The tires create reaction forces against these components in the same direction. The tire reaction forces are due to the friction of the road surface, tire surface condition and pressure. The tire condition changes with tire pressure, treading and temperatures of the tire as well as road surface.

Since the tires are inflated with air, the excessive forces acting on them cause their shape to change, creating a more uniform surface contact with the ground which shifts along the axis of the tire causing shape drag. The traction forces and momentum of the vehicle have to overcome the shape drag as it is shifted along the tire axis during motion. Large amount of friction is required during acceleration and braking or during steep turns especially when travelling at high speed. Since the tires can only handle a limited amount of force acting on it so any excessive forces acting on it will cause saturation, creating excessive slip in them [1].

In non-ABS cars during heavy braking, the braking force applied by the hydraulic brakes is so high that it causes the tires to

stop moving, called wheel lock. This problem can happen at any velocity resulting into excessive slip. Since the tires can create friction against slip until they reach saturation, most ABS systems are designed to avoid excessive tire saturation by braking until it reaches saturation and then allow it to free run until braking can again be applied called, Switched Braking. The slip (S) caused by the tires at a particular velocity is calculated as a ratio of difference of the velocity of the automobile and the measured wheel angular velocity  $\omega_m$  multiplied with the measured tire radius  $r_m$ . Since it is not possible to measure the effective tire radius 'r' so measured tire radius  $r_m$  is considered. Similarly due to the non-availability of the actual speed of the vehicle it is not possible to measure the slip accurately. Instead most antilock braking systems use the reference velocity as vehicle velocity calculated using the average angular velocities of the wheels and the measured radius of the tires to calculate the approximate slip [2].

There are some recent ABS that use model based or optimal kinematics observer as well. This method requires several inertial measurements to estimate the velocity using nonlinear observer and most of the inertial sensors have measurements coupled with noise and biases which change with time, temperature and aging. Due to their randomness they are more suitable for stochastic observers like kalman filters which are difficult to implement and maintain.

2.0 PROPOSED METHOD

The forces acting on the tires are calculated using half car or bicycle model which is presented in Figure 1.

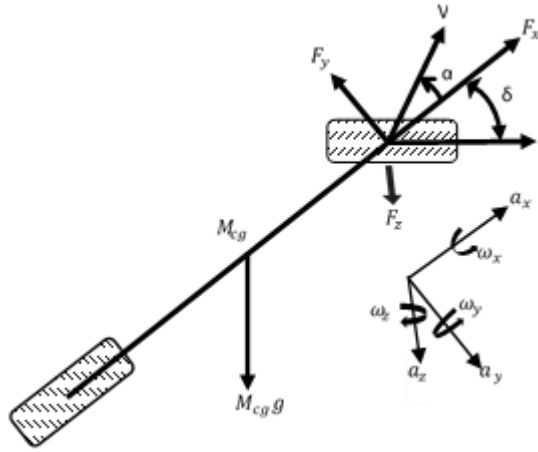

Figure 1 Force diagram of the bicycle model

The various variables used in the proposed method are defined in Table 1.

Table 1 List of variables used

Symbol	Definition	Units
$F = [F_x, F_y, F_z], F_d$	Force vector and driving force	N
$F_t, F_R, F_N = [F_{NF}, F_{NR}]$	Tractive, Resistive and Normal forces	N
$V = [V_x, V_y, V_z], \dot{V}$	Velocity and change in velocity of the vehicle	m/s
$V_{wheel}, \dot{V}$	Vehicle velocity calculated from the wheel speeds and the estimated vehicle velocity	m/s
$a_i = [a_{xi}, a_{yi}, a_{zi}]$ $b, \alpha_i, \delta$	Acceleration vector in $i^{th}$ frame Brake input, tire slip angle of tire $i$ , steering angle	$m/s^2$ Rad
$\Omega_i = [\omega_x, \omega_y, \omega_z]$ $\sigma = [\theta, \phi, \varphi]$ $\mu_i, \epsilon, k_1, k_2$	Angular velocity vector in $i^{th}$ plane Vehicle attitude vector Coefficient of friction, brake control function, brake pressure factors for front and rear tires	rad/s Rad -
$w = [\omega_{FL}, \omega_{FR}, \omega_{RL}, \omega_{RR}]$	Measured angular velocities of each wheel	rad/s

In this diagram the force vector F acting on the bicycle is given by Equation (3).

$$\left. \begin{aligned} F_x &= M_{cg}g \sin \theta + F_t \\ F_y &= M_{cg}g \cos \theta \sin \phi + F_R \\ F_z &= M_{cg}g \cos \theta \cos \phi + F_N \end{aligned} \right\} \quad (3)$$

This equation shows that for calculating the force vector F on each wheel, the weight of the vehicle ( $M_{cg}$ ), the attitude vector  $\sigma$  and the normal, resistive and traction forces have to be known. The tractive force  $F_t$  is positive during acceleration indicating the driving force and negative during braking indicating the braking force acting on the wheel. The resistive force is the resistance of the tires against lateral motion due to sideslips. The normal force indicates the reaction forces on each tire, which changes with the weight distribution and attitude of the vehicle. Since the attitude vector is often small, most methods neglect their effect and assume the forces acting on the tires to consist of equal reaction

forces due to equal distribution of the vehicle weight [2]. By using this assumption, it is possible to estimate the force vector and use it to design a suitable controller that limits the forces that cause slip. A suitable controller can be a sliding mode controller as designed by Kacoo and Tomizuka [3] or by employing feedback linearization [4] with linear PID controller without considering the actual deceleration of velocity of the vehicle.

By directly controlling the forces to control the slip an accurate estimation of the forces is required. The forces presented in Equation (3) are dependent upon the weight of the vehicle, the location of the center of gravity of the vehicle and the attitude of the vehicle. All these parameters are difficult to estimate accurately using inertial measurements therefore, this method is not often used. In most methods the slip is directly estimated and used to control the braking force. In this case the system performance depends upon accurate estimation of slip which is directly related to the accurate estimation of the vehicle velocity. It is possible to estimate the velocity using optimal methods like kalman filters with precision using expensive sensors but resulting into expensive alternatives and complicated maintenance.

Since the purpose of the ABS controller is to reduce slip, while slip is controlled using sufficient brake force, the proposed system attempts to estimate the true slip using a simpler estimation method that does not depend heavily on the sensor performance, which is a function of cost, calibration and aging, in order to control the braking force appropriately.

The slip (S) caused by the tires at any velocity is given by the following Equation [1, 2].

$$S = \frac{(v - r_m \omega_m)}{v} \quad (1)$$

According to Equation (1), the wheel speed is always going to be less than the actual vehicle speed. In most ABS systems the vehicle velocity is calculated from the four wheel angular velocities using the following equation.

$$V_{wheel} = \max((\omega_{fl} + \omega_{fr})/2, (\omega_{rl} + \omega_{rr})/2)R \quad (2)$$

In the proposed system the estimated speed of the vehicle will be calculated using the kinematics equation of the vehicle as given in Equation (4).

$$\dot{V} = \Omega_x V + a \quad (4)$$

Like existing systems, the ideal velocity estimated from the wheel speed can also be written according to kinematics equation as shown by Equation (5).

$$\dot{V}_{wheel} = \Omega_x V_{wheel} + a_m \quad (5)$$

By subtracting 5 from 4 and assuming the measured acceleration are accurate enough ( $a_m \approx a$ ), we get

$$\dot{V}_{wheel} - \dot{V} = \Omega_x (V_{wheel} - V) = \Omega_x \tilde{V} \quad (6)$$

Equation (6) shows that the rate of change of difference in the actual velocity and wheel velocity is related to the components of the error velocity, provided the acceleration and angular velocities vector is measured accurately. Hence the kinematic equation for the estimated velocity can be represented by Equation (7).

$$\hat{V} = k_p \Omega_x \tilde{V} + a_m \quad (7)$$

By using Equation (7), the velocity of the vehicle can be estimated from the integration of acceleration and the error in the integration can be reduced by the error in the velocity resolved along the attitude ( $k_p \Omega \times \hat{V}$ ). This term is the innovative term responsible for eliminating the error in the acceleration component and the angular velocity matrix ( $\Omega$ ). Figure 2 represents the block diagram of the estimator.

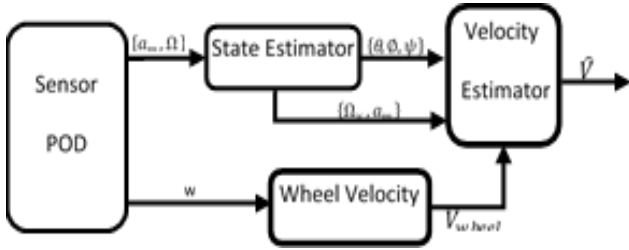

Figure 2 Block diagram of the velocity estimator

In the proposed method the brake control system uses the estimated linear velocity of the automobile and wheel angular velocities of each wheel to calculate the slip in each wheel according to Equation (1). The wheel slip is used to switch the braking force to its subsequent wheels with the criteria to have optimal adhesion between the tires and road. Since the tires exhibit nonlinear relationship between slip and adhesion coefficient ( $\mu$ ), a direct analytical formulation as given by Burckhardt is difficult to implement as given by Equation (8), so the relationship of coefficient of friction and wheel slip as presented in Figure 3 is used to select an optimal value offline.

$$\mu_x(S, V) = ((C_1(1 - e^{-c_2 S}) - C_3 S)e^{-c_4 S V}) \tag{8}$$

Here  $C_1$  is the maximum value of the friction curve.  $C_2$  is the friction curve shape,  $C_3$  is the friction curve difference between maximum value and the value at  $S=1$ . Similarly  $C_4$  is the wetness characteristic value and is in the range 0.02 – 0.04 s/m.

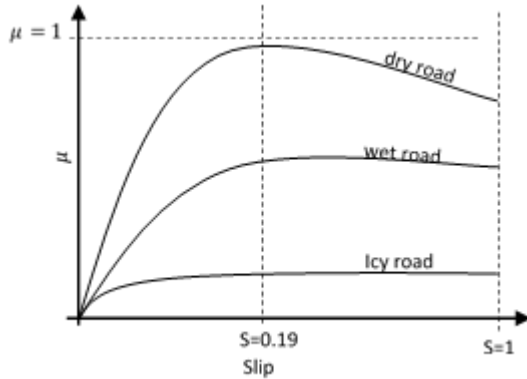

Figure 3 Relationship between adhesion coefficient ( $\mu$ ) and slip in tires running on dry road, wet road and on icy road

It is important to select a true value of slip because it will help in selecting the right coefficient of friction, which is dependent upon the precise estimation of the velocity [1, 2]. Figure 3 shows that at a slip  $S=0.19$ , maximum friction is achieved [2, 3] and when the slip becomes more than 0.19, the adhesion coefficient degrades resulting in the loss of steering ability and longer braking distance. The figure also illustrates the reason of marked ABS failure on icy

and degraded performance on wet roads. Since these road conditions are hard to detect, the value of 0.19 is used in all road conditions.

The system will apply brakes when the slip is below this threshold and when slip becomes more, it will allow the wheels to run freely until brake is applied again at a later stage. The control signal used to switch the brakes is thus given by Equation (9).

$$\epsilon = \begin{cases} 1 & S \leq 0.05 \\ 0 & S > 0.75 \end{cases} \tag{9}$$

In the proposed system the distribution of the braking force in the four tires is not distributed uniformly. Since the automobile shows marked pitching during braking, which is due to the momentum of the vehicle which causes the front suspension to pitch less as compared to the rear suspension. This causes force imbalances, creating more weight over the front tires as compared to the rear ones, which results in lower reaction forces on the rear tires as compared to the front ones. Therefore, the braking system must adapt accordingly to apply less force to the front ones in comparison to the rear ones.

In order to calculate the ratio of weight distribution change between the front and rear tires, we can assume that the automobile center of gravity does not change significantly and the weight distribution is equally placed so that the weight experienced by each wheel is equal to  $M$  when the automobile is stationary. In order to compensate for the brake force between the front and rear suspension, it is assumed that  $k_1$  is the force distribution factor applied to the front suspension and  $k_2$  is the factor applied to the rear suspension such that the reaction forces [ $F_{NF}, F_{NR}$ ] created on the front and rear suspensions in relation to the braking or driving force  $F_d$  are given by Equation (10).

$$\begin{cases} F_{NF} = k_1 F_d = \mu(M_g + M_g \sin \phi) \\ F_{NR} = k_2 F_d = \mu(M_g - M_g \sin \phi) \end{cases} \tag{10}$$

By solving for variable  $k_2$  for equal reactional forces  $F_{NF} = F_{NR}$  we get  $k_2 = k_1 \left( \frac{1 - \sin \phi}{1 + \sin \phi} \right)$

If full braking force is applied to the front wheels ( $K_1 = 1$ ) then the rear suspension braking force is calculated by using the pitch ( $\phi$ ). This helps in maintaining longitudinal stability as well as helps in reducing the braking distance by adjusting the weight imbalance force. Since the pitch is often small ( $\phi < 5$ ), Equation (9) is simplified into a simpler form of Equation (11).

$$k_2 = k_1 \left( \frac{1 - \phi}{1 + \phi} \right) \tag{11}$$

In the proposed system, the attitude is also estimated using complementary filter as proposed in [6]. The estimated pitch is used to calculate the ratio  $k_2$  for proper brake pressure distribution. The brake pressure generated by the hydraulic pump is assumed to be constant during braking and the ABS valve modulator is used to apply, maintain and reduce pressure according to the slip across each wheel and to distribute the brake pressure in the front and rear suspension according to the slip and Equation (10). Although the brake pressure distribution system has some inherent nonlinearities that cause inaccurate and delayed braking, the proposed system assumes it to have the transfer function given by Equation (12).

$$P_{WC}/P_{MC} = b\epsilon k_i / 0.06s + 1 \tag{12}$$

To prevent wheel locking the brakes are applied only when the brake input is from 5% to 75% with the condition that it maintains 75% brake pressure above 75%. The complete model of the system is presented in Figure 4.

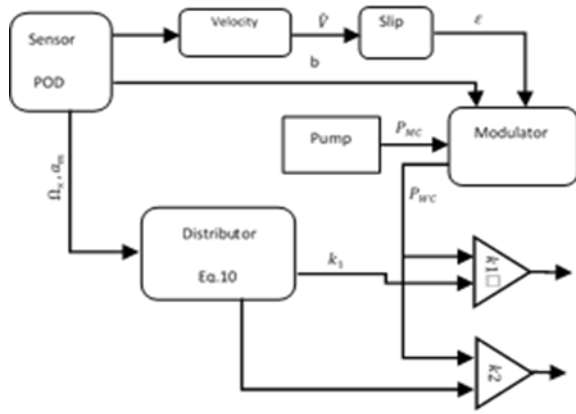

Figure 4 Block diagram of the proposed systems

Real hardware systems often use digital controllers. The angular speed measured from the wheels is measured using hall-effect sensors, which have various inherent biases and delays. It is important to measure the speed of each sensor simultaneously to avoid measurement delays are illustrated in [7]. So for each sensor a dedicated counter with bias removal circuit is implemented.

The IMU sensor suite consists of analog sensors, which are discretized into digital signals. The sensors, if not processed properly will induce random walk with significant biases. A more realistic form would be as follows:

$$\dot{V} = \Omega_x V + a_m + \varepsilon + Nf \tag{13}$$

In this equation the term  $\varepsilon$  represents the sum of the fixed bias of the gyros and the accelerometers. While random walk is a function of the inherent nonlinear random bias offsets of the sensors represented by  $f$  and  $N$  is the amplitude of the random bias. The wheel speed sensors also have bias offsets and random walk noise. Therefore Equation (5) can be generalized in the following form.

$$\dot{V}_{wheel} = \Omega_x V_{wheel} + a_m + \pi + Mf \tag{14}$$

In this equation  $\pi$  is the fixed bias removed by the bias removal circuit and  $f$  is the random noise while  $M$  is the amplitude of the random noise. The type of the random noise is considered same as in the inertial sensors since it is induced by the vehicle model which is same.

As a result of the generalized equations the estimation equation is therefore written as follows:

$$\hat{V} = k_p \Omega_x \tilde{V} + a_m + (\varepsilon - \pi) + (N - M)f \tag{15}$$

This equation shows that the estimation equation tends to reduce the inherent offsets and biases of the sensors. By tuning the low pass filters used in the signal conditioning circuit of the wheel sensors and the inertial sensors, random walk can be reduced. The fixed biases in the inertial sensors are removed by incorporating a moving average filter. The appropriate signal

conditioning circuit used for the wheel speed sensors is given in [7].

### 3.0 RESULTS AND DISCUSSION

Various automobile models were used for the analysis. The first model chosen was a B class hatch back car running at 65Km/h. This model was first chosen because of its inherent instability during heavy braking caused the weight distribution in this type of vehicle. The speed of 65 Km/h was chosen because most often ABS braking is required at high velocity, which in this case is at least 65 Km/h. Since the vehicle behaves differently on different road surfaces, a “split mu test” was carried out to emulate various road surfaces, in which the coefficient of friction was changed from 0.3 for slippery surfaces to 0.5 for moderate road surface after 5 seconds during braking. The switch from slippery to moderate road after 5 seconds was in order to cover various the road conditions. In the simulation, Carsim with Simulink interface for custom controller design was used. The attitude of the vehicle was recorded and compared with estimated states as given by Figure 5. This figure illustrates the efficiency of the estimator in estimating the roll, pitch and yaw, which are subsequently used to distribute brake pressure using Equations (11) and (12). The estimated velocity according to Equation (7) using block diagram given in Figure 2, is also recorded and compared with the actual vehicle velocity which given in Figure 6.

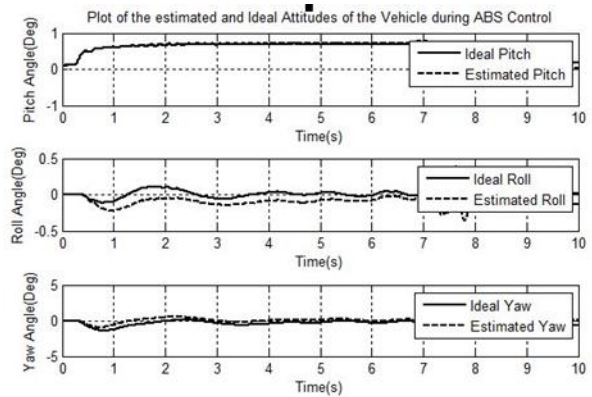

Figure 5 Actual and estimated states of the vehicle during braking from 65 Km/h and employing proposed ABS control

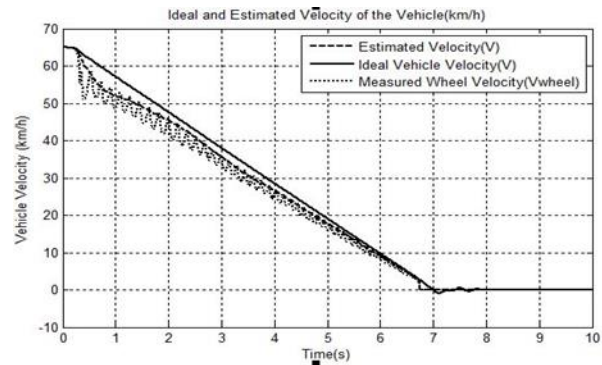

Figure 6 Comparison of the estimated velocity with wheel velocity during braking from 65 Km/h



In this figure, the estimated velocity is close to the actual velocity as compared to the reference velocity until the vehicle comes to a stop state. Since the estimated velocity is close to the actual velocity the slip calculated is also close to the actual slip as compared to the existing systems.

Heavy braking can also result in tremendous heat losses and damage to the braking system due to excessive control effort, it is important to illustrate here how effective the braking system is in reducing the control effort on the brakes, which can be shown by the valve pressures. The output of the valve actuator during braking with the proposed system is also recorded and is given in Figure 7. This figure shows that the output pressure to each wheel changes with slip, which causes an effective switched braking operation of the brakes according to Equation (12).

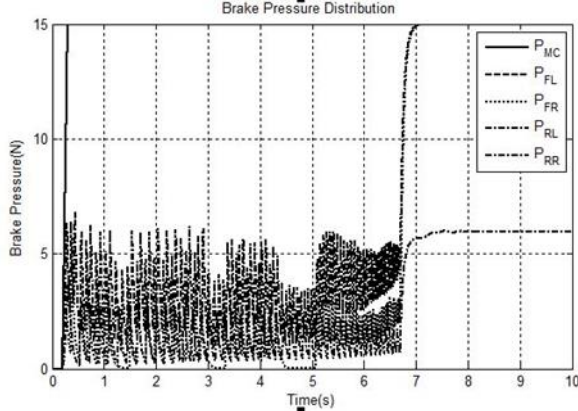

Figure 7 Output pressures of the distributor valve during braking for each wheel implies proper ABS operation

Since the aim of ABS systems is to reduce the stopping distance which is indicated by the braking time, the difference in braking time between the actual velocities based ABS system, proposed velocity based ABS system and existing velocity based ABS system is compared as indicated in Figure 8.

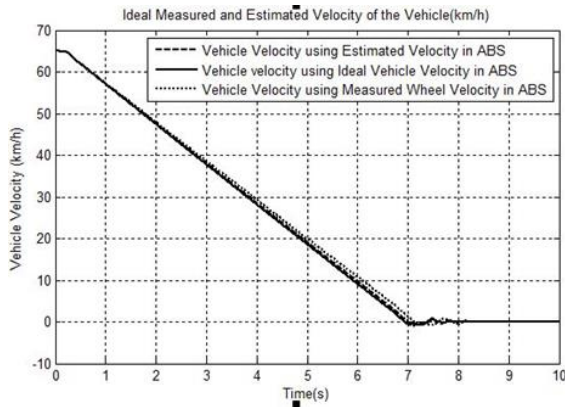

Figure 8 Braking times of various ABS system

The braking times for the proposed system and reference system are also listed in Table 2

Table 2 Performance of various ABS systems

Method Used	Braking Time	Stopping Distance
Conventional wheel speed based ABS	7.131 s	128.75m
Proposed velocity based ABS	7.003s	126.44m
Ideal velocity based ABS	6.943s	125.359m

Table 2 indicates that the proposed system is able to stop the vehicle under the same conditions with 2.131m less stopping distance than the conventional system, which indicates an improvement. Although this distance improvement is not a lot but even 2m reduction in stopping distance can help in preventing a major accident. The results also indicates that a margin of error between the ideal speed based controller and proposed speed based controller is 1.08 m which indicates the possibility to further improve the results.

Similar tests were also carried out on other vehicles. The simulated results obtained in various vehicles are presented in Table 3.

Table 3 Performance of ABS system on various models

Car Type	Ideal Stopping Time	Proposed Stopping Time	Conventional Method Stopping Time
Kenari GX/EX	7.178s	7.221s	7.373s
Myvi-UK Edition	7.181s	7.2184s	7.368s
Mercedes B200- CDI	6.566s	6.568s	6.617s

During hardware implementation the wheel speeds of the four wheels were measured using four parallel counters using EP2C5T mini board FPGA running at a clock speed of 50 MHz for simultaneous measurements to avoid any measurement delays. The ABS algorithm was running on ARM4M processor (STM32F407) which directly controls the modulator using current amplifiers.

The block diagram of the proposed system hardware is illustrated in figure.

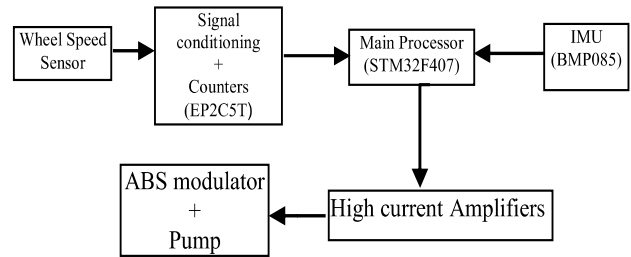

Figure 9 Block diagram of the proposed system hardware implementation

4.0 CONCLUSION

All ABS systems require the actual velocity of the vehicle to accurately calculate the slip and ultimately use it to optimize the adhesion coefficient of the tires for maximum braking possible. Most of the work on ABS system has been focused on the proper control design based on the nonlinear tire characteristics while assuming the velocity calculated from the wheel speeds is accurate

enough for proper slip calculation. By improving the velocity estimation, the performance of ABS control is improved. The proposed method explores the possibility to introduce an observer that can optimize the wheel speed for better speed estimation with the assumption that better speed estimation will result in better ABS control resulting in less braking distance as indicated in Figure 8 and Table 2. The proposed system is tested on different road surfaces using split mu test to indicate that the proposed system works better than conventional ABS on different road conditions as well. The proposed system has a small addition on the conventional system, which is simpler and efficient in estimating the velocity than other estimation methods. These additions are easier to implement due to the introduction of cheaper sensors and simpler algorithms for better control as evident in the paper. There is no doubt that latest control techniques have been able to reduce the braking time further by using better control approaches.

#### Acknowledgement

The authors would like to thank the Ministry of Education Malaysia and Universiti Teknologi Malaysia for their support. This project is supported by Research University Grant 00G19.

#### References

- [1] Georg F. M. 1995. A fuzzy Logic Controller for an ABS Braking System. *IEEE Transactions on Fuzzy Systems*. 3(4): 381–388.
- [2] Yu, J. S. 1997. A Robust Adaptive Wheel-slip Controller for Antilock Brake System. *Proceedings of the 36th Conference on Decision & Control*. 3: 2545–2546.
- [3] Samuel, J. and Jimoh, O. P. 2013. Active Feedback Linearization for Hybrid Slip Control for Antilock Braking Systems. *Acta Polytechnica Hungarica*. 10(1): 81–99.
- [4] Kachroo, P. and Tomizuka, M. 1994. Vehicle Traction Control and Its Applications. *Univ. California, Berkeley, Inst. Transportation, Tech. Rep. UIPRR-94-08*
- [5] Enrico Suraci. 2006. Development and Road Tests of an ABS Control System. *Vehicle System Dynamics*. 44(1): 393–401.
- [6] Fargham Sandhu. 2013. State and Parameter Estimation for Navigation. *In press*.
- [7] Robert, I. L. and Virgil T. 2004. A New Rotational Speed Sensor Interface Circuit with Improved EMC Immunity. *New Trends in Circuits*.