

## CHARACTERISATIONS OF CHROMIUM CARBIDE-BASED COATED COMBUSTOR LINER FOR GAS TURBINES

Salmi Mohd Yunus<sup>a</sup>, Mariyam Jameelah Ghazali<sup>b</sup>, Wan Fathul Hakim W. Zamrib<sup>b</sup>, Ahmad Afiq Pauzi<sup>a</sup>, Shuib Husin<sup>a\*</sup>

<sup>a</sup>Materials Engineering Group, TNB Research Sdn Bhd, Malaysia

<sup>b</sup>Department of Mechanical and Material Engineering, Universiti Kebangsaan Malaysia, Malaysia

### Article history

Received

6 January 2015

Received in revised form

14 April 2015

Accepted

30 May 2015

\*Corresponding author  
shuib@tnbr.com.my

### Graphical abstract



### Abstract

A gas turbine combustor liner experienced visible surface damages during its normal operation of 8000 hours. Small amplitudes of vibration during the operation contributed to a surface degradation, mainly wear. A chromium-carbide based hard coating was deposited via plasma spray technique on the outer surface of a combustor liner of a gas turbine engine. It was found that after the operation, the coating hardness had increased more than 30% compared to its minimum initial hardness and reached up to 744 HV particularly in the crossfire tube collar mating areas. Comparison between the coated and the uncoated liners were carried out in order to show how much the wear scars have been minimized throughout the operation under severe temperature of approximately 1, 500°C. It was found that in this study the coating of chromium-carbide is capable to reduce the wear damage due to the work hardening effect of the liner and their mating surfaces.

Keywords: Chromium carbide, wear characteristics, gas turbine, combustor liner

© 2015 Penerbit UTM Press. All rights reserved

## 1.0 INTRODUCTION

Material surface modification generally consists modifying the surface-structure, either mechanically, chemically or both with additional treatment or modifications by the deposition of a protective layer by utilizing good feedstock with desired properties onto a substrate [1,2]. With attractive mechanical properties like hardness and toughness [3], a product like gas turbines can last under severe condition and environment due to the improved surface, thus reducing their high operational cost [1,4].

A gas turbine is an internal combustion engine that operates with rotary rather than reciprocating motion. During normal operations of a gas turbine, the combustion chamber will experience high temperatures, thus releasing acoustic fluctuations, with small amplitude of vibration [1]. This continuous vibration will cause excessive wear at the mating surfaces of the combustion liner. Figure 1 shows a typical combustor liner in a gas turbine that drives an

electric generator. The exploded view of the combustor liner showed all main connecting components, namely; a fuel nozzle, a flow sleeve, across the fire tube and a transition piece [5].

In this work, the combustor liner is made of a Ni-based material and is connected to different types of connecting materials, such as stainless steel (fuel nozzle collar and crossfire tube collar) and plain carbon steel (liner stop) [6]. These different types of materials have caused severe wear damages, particularly on the softer materials [7]. The necessary improvement of the contacting surface material can be carried out by applying chromium-carbide based hard coating [8, 9].

Commercial chromium-carbide coating is one of the promising candidates due to its high wear resistant performance [10, 11] and suitable for high temperature applications [12, 13]. Castillejo et. al had revealed that chromium-carbide based hard coating is successfully applied in high temperature as wear resistant material [14].

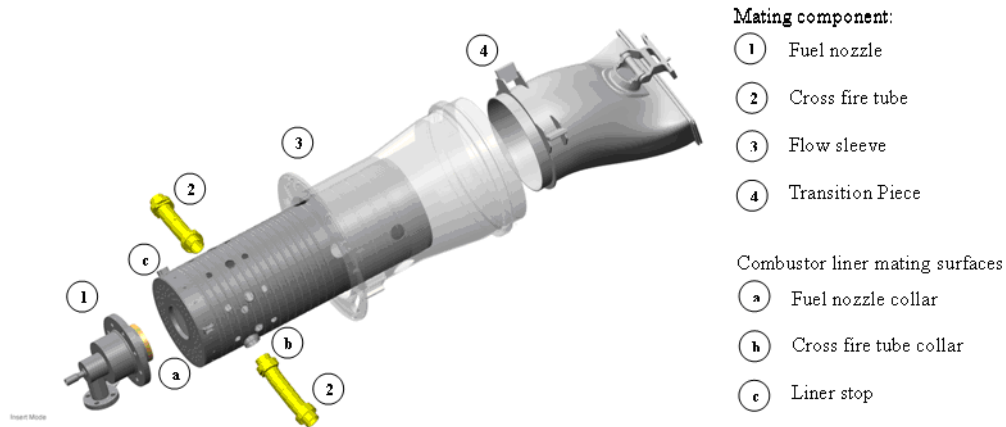

**Figure 1** Exploded view of a combustor liner and its connecting components [6]

## 2.0 EXPERIMENTAL PROCEDURES

The initial coating powder of  $\text{Cr}_3\text{C}_2$  25(Ni 20Cr) also known as chromium-carbide as shown in Table 2 was applied via plasma spray technique. The Ni gave better corrosion resistant whereas Cr content produced both corrosion and wear resistance of the applied coatings [15]. The chromium-carbide based hard coating was applied using air plasma spray technique due to its suitability application on turbine engine components [16]. The detailed parameter used during the deposition is given in Table 1.

### 2.1 Operating Conditions.

The deposited chromium-carbide was applied on the gas turbine combustor liner. Both coated and uncoated combustor liners were exposed to the actual conditions of combustor for 8000 hours at 1500 °C with a pressure of approximately 25 bar. All four crucial mating components of the combustion liner were characterized by using an optical microscope.

**Table 1** Parameter of chromium-carbide deposition [5, 17]

Parameter	Value
Chemical composition of powder [wt.%]	Cr (balance), Ni (18.75), C (9.75), other (2.25)
Ampere [A]	500
Voltage [V]	63~67
Spray rate [lb/hr]	3.2
Max temperature [°C]	200
Spray distance [cm]	7.5~10.0
Turn table speed [rpm]	40
Gun angle [°]	90
Coating thickness [ $\mu\text{m}$ ]	7.5~15.0
No of cycle	-





## 3.0 RESULTS AND DISCUSSION

### 3.1 Visual Observations

Referring to Table 2, the figures show that minimal damages have been occurred on the Cr-C coated surfaces compared to the bare ones. With similar

operating parameter and exposure period, the improvement made by the Cr-C based hard coating is significant.

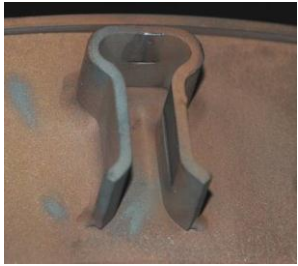
**Table 2** Visual observations on coated and uncoated combustor liner mating surfaces after 8,000 hours operation

Mating surface	Uncoated	Coated
Fuel nozzle collar		
Liner stop		
Cross fire tube collar		

### 3.2 Micrograph Analysis

Selective tear of the coating layer shown in Figure 3 below revealed that an adhesive wear had occurred. Different contrasts along with dark patches were found visible on the contacting areas. These

findings are in agreement with the failure of the adhesive bond symptoms that occurred between similar contact interfaces [6, 18]. The worn surfaces of hard coating showed the materials had re-transferred either from or onto the contacting surfaces.

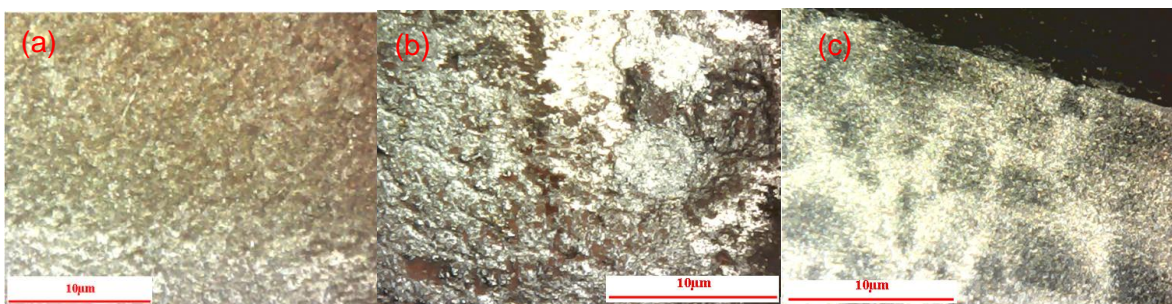

**Figure 2** Micrographs of each mating surfaces after 8,000 hours operation (a) fuel nozzle collar, (b) liner stop, and (c) crossfire tube collar

### 3.3 Hardness Profile

Figure 3 shows the hardness trend of the coated surfaces before and after the operation. It was noted that all coated components had greatly improved

the hardness particularly the cross fire tube collar after 8000 of operating hours. Chromium-carbide has the ability to keep the high hardness property even being exposed to high temperature [19] which means that it retains its strength at high temperatures

very well. These properties make useful as an additive to metal alloys. When chromium carbide crystals are integrated into the surface of a metal it improves the wear resistance of the metal, and maintains these properties at elevated temperatures. The refractory-based coating has the property that upon wearing

at high temperatures, it suffers a serious work hardening in its deformed sliding surface [20]. This work hardening forms a hard layer under the sliding surface, and this hard layer prevents further deformation and further abrasion.

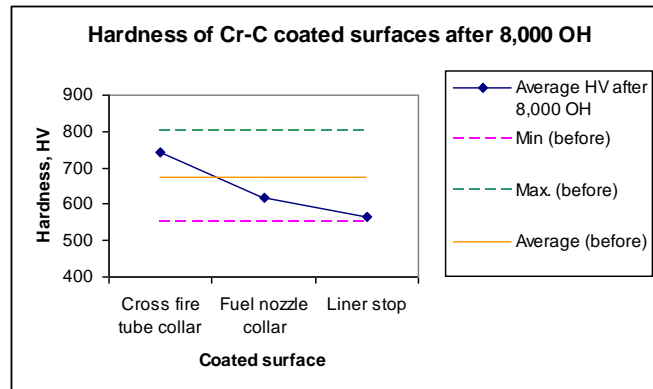

Figure 3 Hardness profile before and after 8, 000 operating hours exposures

#### 4.0 CONCLUSION

Based on the mechanical appearance and analysis, adhesive wear is noted as one of the main damage mechanisms that occurred on the Cr-C coated mating surfaces of combustor liner. Chromium-carbide improved the wear resistance of the metal, and maintains these properties at elevated temperatures, in which it suffers serious work hardening in its deformed sliding surface. Hence, this forms a hard layer under the sliding surface and prevents further deformation and further abrasion.

#### Acknowledgement

The authors would like to thank Tenaga Nasional Berhad for their funding and support in this work.

#### References

- [1] Burnell-Gray, J. S. and Datta, P. K. 1996. Surface Engineering Casebook: Solutions to Corrosion and Wear-related Failures. Woodhead Publishing Limited, England.
- [2] Stokes, J. 2008. *The Theory and Application of the HVOF (High Velocity Oxy-Fuel) Thermal Spray Process*. ISBN, New York.
- [3] Wu, L., Guo X. and Zhang, J. 2014. *Abrasive Resistant Coatings – A Review*. Indiana University, Indiana.
- [4] Fraser, D. and Caso, D. 2006. Inspection Interval Extension and Life Extension of Mature Frame Gas Turbine. *Siemens Power Generation Inc*.
- [5] Johari, A. D., Ghaffar A. K. A. and Ismail, I. 2011. *CLEK Final Report*, TNB Repair & Maintenance Sdn. Bhd. Kuala Lumpur.
- [6] Sahraoui, T., Fenineche, N., Montavon, G. and Coddet, C. 2004. Alternative to Chromium: Characteristics and Wear Behavior of HVOF Coatings for Gas Turbine Shafts Repair (Heavy-duty). *Journal of Materials Processing Technology France*.
- [7] Zikin, A., Hussainova, I., Katsich, C., Badisch, E. and Tomastik, C. 2012. Advanced Chromium Carbide-based Hardfacings. *Surface & Coatings Technology. Elsevier, Austria*.
- [8] Wank, A., Weilage, B., Pokhmuska, H., Friesen, E. and Riesel, G. 2006. Comparison of Hardmetal and Hard Chromium Coatings under Different Tribological Conditions, *Surface & Coatings Technology. Elsevier, Austria*.
- [9] Soares, C. 2008. *Gas Turbine: A Handbook of Air, Land, and Sea Applications*. Elsevier, Oxford. 135-142.
- [10] Yunus, S. M., Sekari S. A. 2014. *Materials Engineering Group*.
- [11] Ghabchi, A. 2011. *Wear Resistant Carbide-based Thermal Sprayed Coatings: Process, Properties, Mechanical Degradation and Wear*. ProQuest, Michigan.
- [12] Chatha, S. S., Sidhu H. S. and Sidhu, B. S. 2012. Characterisations and Corrosion-erosion Behaviour of Carbide-based Thermal Spray Coatings. *Journal of Minerals & Materials Characterisation & Engineering*.
- [13] Dorfman, M. R. 2002. *Wear-Resistant Thermal Spray Coating*. Sulzer Metco, New York.
- [14] Castillejo, F.E., Marulanda, D.M., Olaya J. J. and Alfonso, J. E. 2014. Wear and Corrosion Resistance of Niobium-chromium Carbide Coatings on AISI D2 Produced through TRD. *Surface & Coatings Technology. Elsevier, Colombia*.
- [15] Hejwowski, T., Szewczyk, S. and Weronki, A. 2000. An Investigation of the Abrasive and Erosive Wear of Flame-sprayed Coatings. *Journal of Materials Processing Technology*.
- [16] Oerlikon Metco. 2014. Solution Flash: Produce Excellent Quality PWA 257 High-energy Plasma Sprayed Carbide Coatings with TriplexPro-210. SF-0006.2 - TriplexPro™-210 High Energy Coatings..
- [17] Oerlikon Metco. 2014. Material Product Data Sheet: Chromium Carbide –Nickel Chromium Powder Blends. DSMTS-0112.1 – Cr3C2 - NiCr Alloy Powder Blend
- [18] B. Bushan. 2001. *Modern Tribology Handbook (Vol.1): Principles of Tribology*, CRC Press LLC, Florida
- [19] Department of the Army. 1996. *Fundamentals of Machine Tools*. Washington DC. 2-4 – 2-14.
- [20] Baba, N. and Nishi, K. High-temperature member for use in gas turbine, *Patent File: CA 2419018 A1*.