

ASSESSING THE FORWARD OSMOSIS PERFORMANCES USING CTA MEMBRANE: EFFECT OF SOLUTION VOLUME RATIO AND TYPE OF DRAW SOLUTE

Jeng Yih Law^{a,b}, Abdul Wahab Mohammad^{a*}

Article history

Received

16 October 2015

Received in revised form

4 March 2016

Accepted

16 March 2016

^aDepartment of Chemical and Process Engineering, Faculty of Engineering and Built Environment, Universiti Kebangsaan Malaysia, 43600 UKM Bangi, Malaysia

^bSection of Chemical Engineering Technology, Universiti Kuala Lumpur, Malaysian Institute of Chemical & Bioengineering Technology, Lot 1988, Kawasan Perindustrian Bandar Vendor, Taboh Naning, 78000 Alor Gajah, Melaka, Malaysia

*Corresponding author
drawm@ukm.edu.my

Graphical abstract

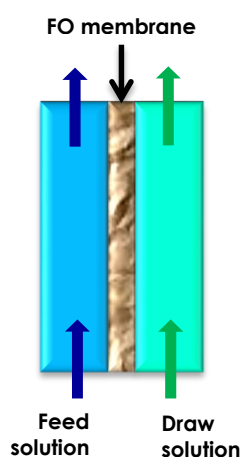

Abstract

Osmotically-driven forward osmosis (FO) has gained significant attention in the last decade due to its potential application in various disciplines. Draw solution serves as the driving force in FO process for inducing water transport across the membrane. FO technology can be used to reject or concentrate high valuable products in the chemical and bioprocess industries which often encounter great challenge in terms of dilute product formation. In this study, commercial cellulose triacetate (CTA) flat sheet FO membrane was investigated using several types of inorganic draw solute. Pure water fluxes ranged from 5.20 to 6.30 L.m⁻².h⁻¹ were achieved for selected draw solutes. The reverse solute leakage was shown by the increment of conductivity in the feed solution. Among the draw solutes, NaCl demonstrated highest reverse solute leakage (72.45 μS cm⁻¹) attributed to its relatively smaller molecular size. The water fluxes at feed to draw solution volume ratios of 1:2 and 1:3 were found to be slightly lower than that to the volume ratios of 1:0.6 and 1:1. With respect to sodium succinate feed solution, MgCl₂ was capable of generating higher osmotic pressure and thus higher water flux was observed compared to NaCl draw solute. Overall, the selected inorganic draw solutes demonstrated encouraging FO performances and could be used for concentrating sodium succinate solution.

Keywords: Forward osmosis, CTA membrane, draw solute, solution volume ratio, conductivity

© 2017 Penerbit UTM Press. All rights reserved

1.0 INTRODUCTION

Forward osmosis (FO) has been considered as an emerging technology even though it has been applied since 40 years ago [1, 2]. Unlike other pressure-driven membrane processes, the osmotic pressure difference serves as the driving force for the migration of water molecule in FO process [3]. FO offers several advantages such as low energy utilisation and membrane fouling propensity, which make it an attractive membrane technology [4–6]. Additionally, FO is also an environmental friendly technology

attributed to its waste-free process despite the use of draw solution as osmotic agent [7].

FO system is simple and easy to handle. A typical bench-scale FO membrane process consists of an FO cell unit, and two solution reservoirs for the feed and draw solutions [8]. Semi-permeable membrane is inserted in between FO cell unit. The flat-sheet cellulose triacetate (CTA) FO membrane with an asymmetric structure and unique physical characteristic, supplied by Hydration Technology Innovations (HTI, Albany, OR, USA) is the most widely applied membrane among researchers [9, 10]. Draw

solution is the osmotic agent of FO that drives the migration of water molecule [11]. The selection of suitable draw solute with appropriate solution concentration can ensure the spontaneous transport of water molecules from feed solution to draw solution compartment. In recent years, many efforts have been made in proposing various types of novel draw solutes [12-14]. One of the major concerns in selecting an appropriate draw solute is the cost of replenishment. Table 1 presents the unit and specific costs for selected draw solutes [15]. Specific cost indicates the cost of draw solute needed to produce 1 L of draw solution with an osmotic pressure of 2.8 MPa. It can be seen that some of the popular draw solutes such as sodium chloride (NaCl) and magnesium chloride (MgCl₂) are among the cheapest draw solutes in the market.

Table 1 Unit and specific costs for various types of draw solute [15]

| Draw solute | Cost, \$/kg | Specific cost, \$/L |
|---|-------------|---------------------|
| NaCl | 15 | 0.53 |
| NH ₄ Cl | 26 | 0.85 |
| MgCl ₂ | 28 | 0.96 |
| NaHCO ₃ | 20 | 1.28 |
| Na ₂ SO ₄ | 8 | 1.28 |
| CaCl ₂ | 35 | 1.53 |
| KCl | 37 | 1.74 |
| KHCO ₃ | 32 | 2.1 |
| NH ₄ HCO ₃ | 45 | 2.38 |
| (NH ₄) ₂ SO ₄ | 60 | 4.46 |
| K ₂ SO ₄ | 53 | 5.38 |
| KBr | 80 | 5.7 |
| Ca(NO ₃) ₂ | 70 | 6.1 |
| MgSO ₄ | 52 | 7.35 |

Succinic acid is a dibasic organic acid with the molecular formula C₄H₆O₄. It is widely used as specialty chemicals in chemical, food and pharmaceutical industries. Some of the important applications include the production of biodegradable polymers, surfactants/detergents, cosmetics, and foaming agents [16, 17]. Succinic acid can be produced via chemical process or microbial fermentation [16, 18]. The chemical synthesis involves

the use of liquefied petroleum gas (LPG) or petroleum oil as a starting material. Nevertheless, the unpredictable petroleum price has resulted in growing interest of microbial fermentation process [16, 19]. The downstream recovery cost for the fermentation based process typically accounts for 50%-80% of the total production cost [19]. Hence, careful selection of appropriate downstream process for the recovery of succinic acid is crucial. Many efforts have been done by previous researchers in proposing various recovery and concentration processes [16, 20]. These methods, however, may not be economically viable and attractive, and therefore improvements are constantly being performed and new methods are being explored.

The objective of the present work is to perform the preliminary investigation on the performance of FO process. Specifically, a systematic investigation on the effect of feed solution to draw solution volume ratio, and type of draw solute were performed in the study. Water flux across a semi-permeable membrane has always been used as an evaluation for the FO performance. Cheap and economically viable solutes including sodium chloride and magnesium chloride were selected as draw solution for the sodium succinate concentration process. The regeneration of these draw solutions can be eliminated via replenishment, and thus lowering the energy utilisation of the entire system.

2.0 METHODOLOGY

2.1 Feed and Draw Solutions

Sodium chloride (NaCl) and sodium sulfate (Na₂SO₄) were purchased from Merck. Sodium succinate and magnesium chloride (MgCl₂) were purchased from Acros Organics, and R&M Chemicals, respectively. Ultrapure (UP) water with a high resistivity of 18.2 MΩ·cm was used to prepare synthetic feed solution (UP water, sodium succinate) and draw solution (NaCl, MgCl₂, Na₂SO₄).

2.2 FO Performance Experiments

The FO experiment was conducted in a flat sheet membrane module as illustrated in Figure 1. The FO asymmetric membrane (CTA) developed by Hydration Technologies Innovations (Albany, OR, USA) was used in this study. The membrane consists of cellulose triacetate active layer with embedded polyester screen support. The CTA membrane was inserted between the FO cell (Sterlitech CF042 Cell) in which two compartments namely feed solution and draw solution compartments were formed. The effective membrane area employed in the study was 0.0042 m². Two peristaltic pumps (BT600-2J, LongerPump, China) were employed for circulating the solutions at a flow rate of 0.53 L/min in separate compartments. Experiments were conducted for

approximately 150 min. During the FO experiment, water molecule migrated from the feed solution to the draw solution compartment as a result of osmotic pressure difference. The migration of water molecules would eventually change the water level in both compartments.

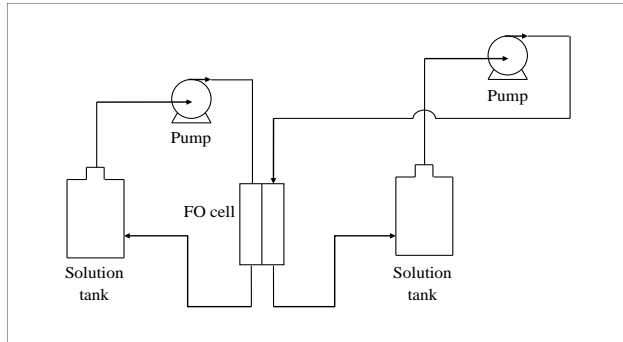

Figure 1 Schematic diagram for the experimental set-up of FO system

2.3 Measurements and Analysis

A weighing balance (PGL10001, Adam, United Kingdom) was used to measure the mass increase of draw solution weight. The water flux (J_w) is determined using Equation 1 [3]:

$$J_w = \frac{\Delta m}{1000 \times A \times \Delta t} \quad (1)$$

where Δm (g) is the mass variation due to water migration over a period of time in the FO process, Δt (h); A (m^2) is the effective membrane area, and the density of water is assumed as 1000 g L^{-1} . Additionally, the volume variation was also measured at the end of FO process as comparison of water flux. Conductivity meter (Mi306, Martini, Romania) was used in the study to monitor the reverse solute leakage of various draw solutes.

3.0 RESULTS AND DISCUSSION

3.1 Effect of Draw Solute on Pure Water Flux

To elucidate the effect of draw solute on FO process, experiments were conducted by employing three different types of draw solute. UP water was used as the feed solution. The performance of FO process was evaluated in terms of water flux across the semi-permeable membrane. Figure 2 presents the pure water flux profiles for MgCl_2 , NaCl , and Na_2SO_4 . At 1.0 M initial draw solution concentration, MgCl_2 and Na_2SO_4 generated comparable water flux. Water flux of generally higher than $5.00 \text{ L}\cdot\text{m}^{-2}\cdot\text{h}^{-1}$ was achieved for all the selected draw solutes. A slight decline of water flux over a time period was observed. During the FO process, water molecule migrated from the feed solution to the draw solution compartment. As a result,

the draw solution was diluted by the migration of water molecules, thereby causing a slight decline in water flux.

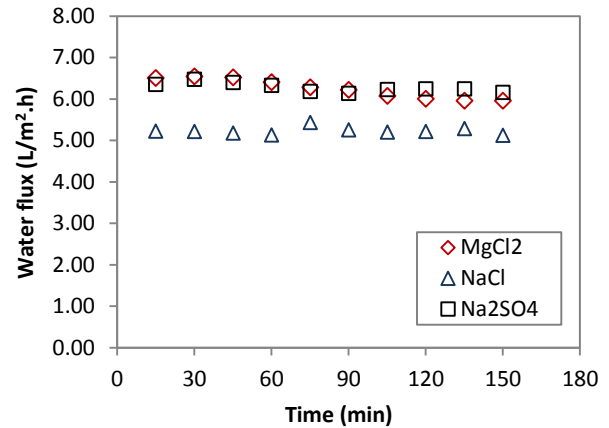

Figure 2 Effect of draw solute on the pure water flux

Figure 3 shows the osmotic pressure of various draw solutions at 1.0 M concentration. Of all the draw solutes, MgCl_2 has exhibited the greatest osmotic pressure of 95.5 atm. FO is a natural osmotic-driven process, the increment in osmotic pressure would facilitate water flux across the membrane [21]. Interestingly, Na_2SO_4 demonstrated higher water flux compared to NaCl even though both solutes generated comparable osmotic pressures at 1.0 M concentration. The difference in water flux performance was due to the undesired internal concentration polarization effect [14, 15]. Comparing the mass concentration of draw solution, it was found that the mass of solute needed to produce 1.0 M of Na_2SO_4 draw solution was the highest. Hence, careful selection of draw solute is vital to ensure minimum cost of replenishment.

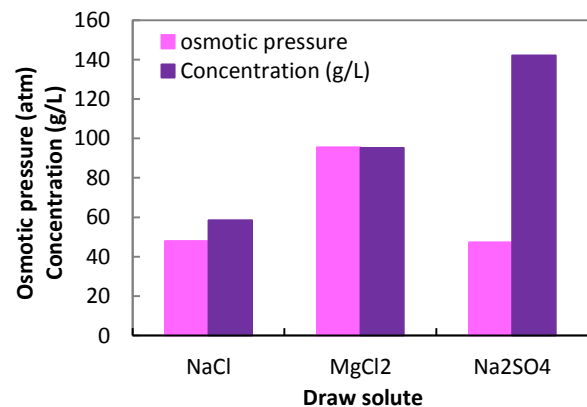

Figure 3 Osmotic pressure and concentration (g/L) of draw solution

3.2 Effect of Draw Solute on Reverse Solute Leakage

Reverse solute leakage is the back flow of draw solute across the semi-permeable membrane joining the feed solution. It is often known as reverse solute flux or draw solute leakage. Figure 4 exhibits the conductivity of feed solution for different types of draw solute employed in the study. The behaviour of reverse solute leakage was investigated using UP water as the feed solution. It was found that the conductivity of the feed solution increases over the time period of 150 minutes. Similar linear relationships have been observed in all the plotted curves. The increment of feed solution conductivity was due to the ion leakage phenomenon. An increase in electrolyte concentration may give rise to a corresponding increase in conductivity of feed solution [22]. Among the draw solutes, a relatively higher conductivity was reported for NaCl draw solute indicating higher leakage of NaCl solute into the feed compartment.

The behaviour of reverse solute leakage can be explained by comparing the molecular size of these solutes [14]. NaCl is a monovalent salt that consists of monovalent cation (Na^+) and monovalent anion (Cl^-). By contrast, MgCl_2 and Na_2SO_4 are larger size divalent salts containing divalent cation (Mg^{2+}) and divalent anion (SO_4^{2-}), respectively. Hence, the observed reverse solute leakage of MgCl_2 and Na_2SO_4 were significantly lower than that of NaCl draw solute. It has been reported that reverse solute leakage might cause complications to the feed solution [23]. Moreover, reverse solute leakage can cause dilution to draw solution and thereby reducing the net osmotic pressure difference across the FO membrane. Overall, the observed reverse solute leakages in the present study are considerably low but are expected to increase with the increase of draw solution concentration. Replenishment of draw solution may be performed after prolong period of FO process to retain the desired water flux.

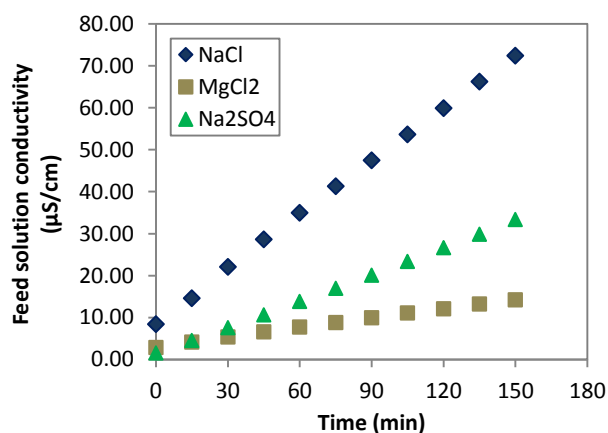

Figure 4 Conductivity of feed solution for different types of draw solute

3.3 Effect of Feed Solution to Draw Solution Volume Ratio

Figure 5 shows the comparison of water flux at different feed to draw solution volume ratios. Four different volume ratios (1:0.6, 1:1, 1:2 and 1:3) were employed in the study. The initial sodium succinate feed solution volume was 1 L and the NaCl draw solution volume was varied accordingly. As Figure 5 shows, there was no discernible variation in the water flux at different volume ratios. One interesting finding is that the water fluxes at volume ratios of 1:2 and 1:3 were found to be slightly lower than that to the volume ratios of 1:0.6 and 1:1. The slight variation in the water flux performance is attributed to concentration polarization phenomenon. During the FO mode membrane orientation, the permeation of water at the permeate side of the membrane causes the dilution of draw solution at the support layer interface. This phenomenon is known as dilutive internal concentration polarization. By contrast, the concentrative external concentration polarization phenomenon is due to the build-up of feed solute in higher concentrations at the active layer interface of the membrane [24]. When higher initial draw solution volume was employed in the study (volume ratios of 1:2 and 1:3), the mixing of permeating water with the NaCl draw solution could take a longer duration to achieve a homogeneous mixture and thus leading to a more pronounced effect of dilutive internal concentration polarization. As a result, unsatisfying water flux performance was observed.

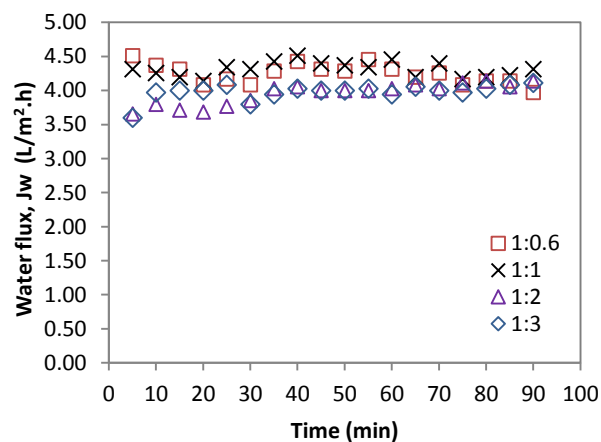

Figure 5 Experimental water flux profiles as a function of time at varying feed to draw solution volume ratios. NaCl 1 M was used as draw solution

3.4 FO Concentration of Sodium Succinate using Different Types of Draw Solute

In this section, comparison was made between MgCl_2 and NaCl draw solutes for concentrating sodium succinate solution (Figure 6). As can be seen, similar water flux profiles were obtained using different types of draw solute. At the same initial draw solution

concentration (1.0 M), MgCl_2 could induce greater migration of water molecule across the FO membrane compared to the NaCl draw solution. This is due to the fact that MgCl_2 generated higher osmotic pressure at 1.0 M concentration (Figure 7). Operation of FO process at higher osmotic pressure produced greater water flux and reduced the duration of FO process for achieving the desired final solution concentration. According to Figure 7, the osmotic pressure generated by MgCl_2 was nearly twice as high as the osmotic pressure generated by NaCl . Nevertheless, the water flux obtained in the experiment did not increase in proportion with the osmotic pressure. Similar observation has been reported in our previous work [14].

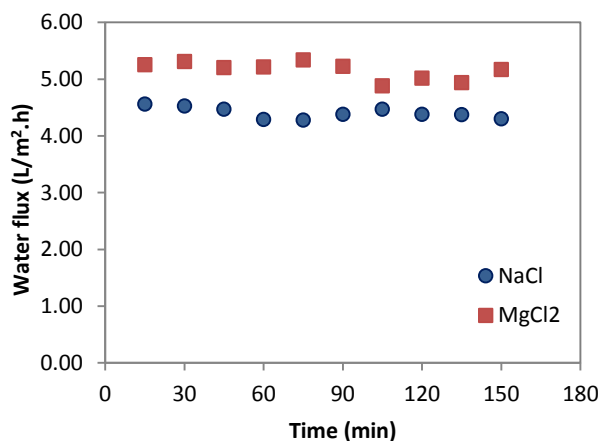

Figure 6 Comparison of water flux performance using NaCl and MgCl_2 draw solution, and 0.12 M sodium succinate feed solution

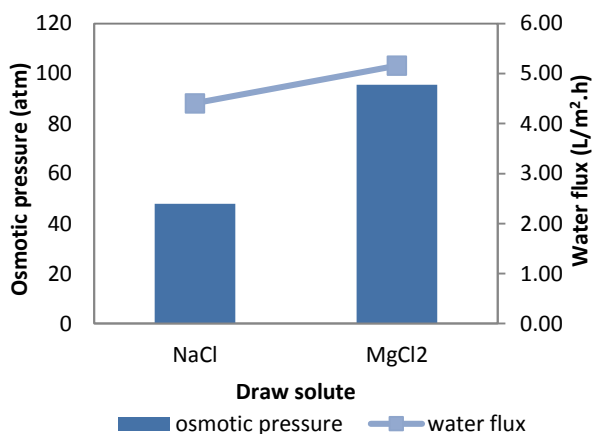

Figure 7 Average water flux and osmotic pressure of NaCl and MgCl_2 draw solutions at 0.12 M initial sodium succinate concentration

4.0 CONCLUSION

There are many factors affecting the performance of osmotically-driven FO process. In this work, inorganic

salts including NaCl , MgCl_2 , and Na_2SO_4 were employed as draw solutes. In all cases, the water flux did not show significant deterioration at given experimental time period. The reverse solute leakage is highly undesired as it reduces the draw solution concentration and complicates the feed solution composition. Encouragingly, the reverse solute leakages for all the selected draw solutes were considerably low. Divalent salt with relatively larger molecular size outperformed monovalent salt exhibiting low reverse solute leakage. There was no discernible variation in the water flux at different feed to draw solution volume ratios. Concentration polarization is an inevitable phenomenon that led to unsatisfying water flux performances in FO process. Comparative study on the concentration of sodium succinate solution revealed that MgCl_2 was capable of generating a relatively higher water flux than the NaCl draw solution attributed to higher osmotic pressure driving force.

Acknowledgement

The authors wish to gratefully acknowledge the financial support for this work provided by the LRGS/2013/UKM-UKM/PT/03 grant from the Ministry of Education Malaysia.

References

- [1] Kravath, R. E., and J. A. Davis. 1975. Desalination of Sea Water by Direct Osmosis. *Desalination*. 16: 151-155.
- [2] Kessler, J. O., and C. D. Moody. 1976. Drinking Water from Sea Water by Forward Osmosis. *Desalination*. 18: 297-306.
- [3] Li, D., X. Zhang, G. P. Simon, and H. Wang. 2013. Forward Osmosis Desalination Using Polymer Hydrogels as a Draw Agent: Influence of Draw Agent, Feed Solution and Membrane on Process Performance. *Water Research*. 47: 209-215.
- [4] McGinnis, R. L., and M. Elimelech. 2007. Energy Requirements of Ammonia-carbon Dioxide Forward Osmosis Desalination. *Desalination*. 207: 370-382.
- [5] Zhao, S., L. Zou, C. Y. Tang, and D. Mulcahy. 2012. Recent Developments in Forward Osmosis: Opportunities and Challenges. *Journal of Membrane Science*. 396: 1-21.
- [6] Liu, Y., and B. Mi. 2012. Combined Fouling of Forward Osmosis Membranes: Synergistic Foulant Interaction and Direct Observation of Fouling Layer Formation. *Journal of Membrane Science*. 407-408: 136-144.
- [7] Hoover, L. A., W. A. Phillip, A. Tiraferri, N. Y. Yip, and M. Elimelech. 2011. Forward with Osmosis: Emerging Applications for Greater Sustainability. *Environmental Science & Technology*. 45: 9824-9830.
- [8] Law, J. Y., and A.W. Mohammad. 2017. Employing Forward Osmosis Technology through Hybrid System Configurations for the Production of Potable/Pure Water: A Review. *Jurnal Teknologi*. 79: 125-135.
- [9] Jin, X., J. Shan, C. Wang, J. Wei, and C. Y. Tang. 2012. Rejection of Pharmaceuticals by Forward Osmosis Membranes. *Journal of Hazardous Materials*. 227-228: 55-61.
- [10] Nguyen, N. C., S.-S. Chen, H.-Y. Yang, and N. T. Hau. 2013. Application of Forward Osmosis on Dewatering of High Nutrient Sludge. *Bioresource Technology*. 132: 224-229.

- [11] Chung, T.-S., X. Li, R. C. Ong, Q. Ge, H. Wang, and G. Han. 2012. Emerging Forward Osmosis (FO) Technologies and Challenges Ahead for Clean Water and Clean Energy Applications. *Current Opinion in Chemical Engineering*. 1: 246-257.
- [12] Stone, M. L., C. Rae, F. F. Stewart, and A. D. Wilson. 2013. Switchable Polarity Solvents as Draw Solute for Forward Osmosis. *Desalination*. 312: 124-129.
- [13] Stone, M. L., A. D. Wilson, M. K. Harrup, and F. F. Stewart. 2013. An Initial Study of Hexavalent Phosphazene Salts as Draw Solute in Forward Osmosis. *Desalination*. 312: 130-136.
- [14] Law, J. Y., and A. W. Mohammad. 2017. Multiple-solute Salts as Draw Solution for Osmotic Concentration of Succinate Feed by Forward Osmosis. *Journal of Industrial and Engineering Chemistry*. 51: 264-270.
- [15] Achilli, A., T. Y. Cath, and A. E. Childress. 2010. Selection of Inorganic-Based Draw Solutions for Forward Osmosis Applications. *Journal of Membrane Science*. 364: 233-241.
- [16] Song, H., and S. Y. Lee. 2006. Production of Succinic Acid by Bacterial Fermentation. *Enzyme and Microbial Technology*. 39: 352-361.
- [17] Kang, S. H., and Y. K. Chang. 2005. Removal of Organic Acid Salts from Simulated Fermentation Broth Containing Succinate by Nanofiltration. *Journal of Membrane Science*. 246: 49-57.
- [18] Law, J. Y., and A. W. Mohammad. 2017. Separation of Succinate from Organic Acid Salts Using Nanofiltration Membranes. *Chemical Engineering Transactions*. 56: 1705-1710.
- [19] Song, H., Y. S. Huh, S. Y. Lee, W. H. Hong, and Y. K. Hong. 2007. Recovery of Succinic Acid Produced by Fermentation of a Metabolically Engineered *Mannheimia succiniciproducens* Strain. *Journal of Biotechnology*. 132: 445-452.
- [20] Khairul Zaman, N., J. Y. Law, P. V. Chai, R. Rohani, and A. W. Mohammad. 2017. Recovery of Organic Acids from Fermentation Broth Using Nanofiltration Technologies: A Review. *Journal of Physical Science*. 28: 85-109.
- [21] Kim, T., Y. Kim, C. Yun, H. Jang, W. Kim, and S. Park. 2012. Systematic Approach for Draw Solute Selection and Optimal System Design for Forward Osmosis Desalination. *Desalination*. 284: 253-260.
- [22] Tian, E., C. Hu, Y. Qin, Y. Ren, X. Wang, X. Wang, P. Xiao, and X. Yang. 2015. A Study of Poly (Sodium 4-Styrenesulfonate) as Draw Solute in Forward Osmosis. *Desalination*. 360: 130-137.
- [23] Lee, S., C. Boo, M. Elimelech, and S. Hong. 2010. Comparison of Fouling Behavior in Forward Osmosis (FO) and Reverse Osmosis (RO). *Journal of Membrane Science*. 365: 34-39.
- [24] Zhao, S., and L. Zou. 2011. Relating Solution Physicochemical Properties to Internal Concentration Polarization In Forward Osmosis. *Journal of Membrane Science*. 379: 459-467.